

3-11-2011

Evaluation of the Single Keybit Template Attack

Eric W. Garcia

Follow this and additional works at: <https://scholar.afit.edu/etd>

Part of the [Electromagnetics and Photonics Commons](#), and the [VLSI and Circuits, Embedded and Hardware Systems Commons](#)

Recommended Citation

Garcia, Eric W, "Evaluation of the Single Keybit Template Attack" (2011). *Theses and Dissertations*. 1387.
<https://scholar.afit.edu/etd/1387>

This Thesis is brought to you for free and open access by the Student Graduate Works at AFIT Scholar. It has been accepted for inclusion in Theses and Dissertations by an authorized administrator of AFIT Scholar. For more information, please contact richard.mansfield@afit.edu.



**Evaluation Of The Single Keybit Template
Attack**

THESIS

Eric W. Garcia, Captain, USAF
AFIT/GE/ENG/11-11

**DEPARTMENT OF THE AIR FORCE
AIR UNIVERSITY**

AIR FORCE INSTITUTE OF TECHNOLOGY

Wright-Patterson Air Force Base, Ohio

APPROVED FOR PUBLIC RELEASE; DISTRIBUTION UNLIMITED

The views expressed in this document are those of the author and do not reflect the official policy or position of the United States Air Force, the United States Department of Defense or the United States Government. This material is declared a work of the U.S. Government and is not subject to copyright protection in the United States.

AFIT/GE/ENG/11-11

EVALUATION OF THE SINGLE KEYBIT TEMPLATE ATTACK

THESIS

Presented to the Faculty
Department of Electrical and Computer Engineering
Graduate School of Engineering and Management
Air Force Institute of Technology
Air University
Air Education and Training Command
in Partial Fulfillment of the Requirements for the
Degree of Master of Science in Electrical Engineering

Eric W. Garcia, B.S.E.E.

Captain, USAF

March 2011

APPROVED FOR PUBLIC RELEASE; DISTRIBUTION UNLIMITED

EVALUATION OF THE SINGLE KEYBIT TEMPLATE ATTACK

Eric W. Garcia, B.S.E.E.
Captain, USAF

Approved:

//signed//

1 March 2011

Dr. Rusty O. Baldwin
Thesis Advisor

Date

//signed//

1 March 2011

Dr. Michael A. Temple
Committee Member

Date

//signed//

1 March 2011

Maj. Michael J. Mendenhall, PhD
Committee Member

Date

Abstract

Side Channel leakage is a serious threat to secure devices. Cryptographic information extraction is possible after examining any one of the various side channels, including electromagnetic. This work contributes a new method to achieve such a purpose. The Single Keybit Template Attack (SKTA) is introduced as a means to extract encryption keys from embedded processors and other integrated circuit devices performing DES encryptions by passively monitoring and exploiting unintentional RF emissions. Key extraction is accomplished by creating two templates for each bit value of the key based on instantaneous amplitude responses as a device executes DES operations. The resultant templates are input to a Maximum Likelihood processor for subsequent template discrimination with RF emissions captured from a target device. Plaintext and ciphertext are not necessary for SKTA to function. Using 8-bit microcontroller devices and experimentally collected side channel signals, key extraction is possible after examination of approximately 300 RF emission traces. After consideration of SKTA's capabilities, embedded processors using DES to process sensitive data warrants reconsideration.

Table of Contents

	Page
Abstract	iv
List of Figures	vii
List of Tables	ix
List of Abbreviations	x
I. Introduction	1
1.1 Background	1
1.2 Statement of Problem	1
1.3 Thesis Scope, Limitations and Assumptions	2
1.4 Methodology Overview	3
1.5 Thesis Chapters Overview	4
II. Background	5
2.1 Encryption Standards	5
2.1.1 Data Encryption Standard	5
2.1.2 Advanced Encryption Standard	6
2.2 Hamming Distance Leakage Model	8
2.3 Statistics Background	13
2.3.1 Correlation	13
2.3.2 Baye's Rule	15
2.4 Types of Side Channel Analysis	17
2.4.1 Simple Power and Electromagnetic Analysis	18
2.4.2 Differential Power and Electromagnetic Analysis	18
2.4.3 Template Analysis	19
2.5 Template Attack Techniques	21
2.5.1 Single Keybit Template Attack	21
2.5.2 Template Enhanced Differential Analysis	22
2.6 Summary	23
III. Methodology	24
3.1 Problem Definition	24
3.1.1 Goals	24
3.1.2 Hypotheses	24
3.1.3 Approach	25
3.2 System Boundaries	26
3.3 System Services	27
3.4 Workload	27

	Page
3.5 Measures of Performance	27
3.6 System Parameters	28
3.7 Factors	30
3.8 Evaluation Technique	31
3.9 Experimental Configuration	31
3.9.1 Experimental Setup	32
3.9.2 Signal Collection	33
3.9.3 Feature Extraction and Classification	35
3.10 Experimental Design	35
3.11 Methodology Summary	35
IV. Results	36
4.1 DES	36
4.1.1 Number of Observations	36
4.1.2 Key Guessing Entropy	37
4.2 AES	38
4.2.1 Number of Observations	38
4.2.2 Key Guessing Entropy	39
4.3 Summary	40
V. Conclusion	41
5.1 Summary of Findings	41
5.2 Limitations of Findings	42
5.3 Suggested Follow-on Research	42
5.4 Summary	43
A. Pilot Studies	45
A.1 Signal Domain	45
A.2 Data Bandwidth	46
Bibliography	49
Vita	51

List of Figures

Figure	Page
1. 16-Round DES Encryption Algorithm	7
2. XORing of Permuted Plaintext E with Permuted Round Key K_n Before Entry Into 8 S-boxes	8
3. AES Substitute Bytes Transformation	9
4. AES Shift Rows Transformation	9
5. AES Mix Columns Transformation	9
6. AES Add Round Key Transformation	10
7. DES electromagnetic signal trace of 16 encryption rounds	10
8. AES electromagnetic signal trace of 10 encryption rounds	11
9. Visible Hamming distances of mean signal traces of one keybit for values “0” and “1”	12
10. Visible Hamming distances of mean signal traces for 6-bit S-box inputs “0” through “63”	12
11. DES Correlation Between Signal Trace and Keybit	14
12. AES Correlation Between Signal Trace and Keybit	15
13. DES Correlation Between Signal Trace and S-box Input	16
14. AES Correlation Between Signal Trace and S-box Input	16
15. Evolution of key hypothesis probabilities as the number of observed traces increases	21
16. Key Extraction System	26
17. Key Extraction System Setup	32
18. DES: Number of target signal trace observations for SKTA and TEDA	37
19. DES: Key guessing entropy for SKTA and TEDA	38

Figure	Page
20. AES: Number of target signal trace observations for SKTA and TEDA	39
21. AES: Key guessing entropy for SKTA and TEDA	40
22. DES Template Classification Performance with Respect to Signal Domain	46
23. AES Template Classification Performance with Respect to Signal Domain	47
24. AES Template Classification Performance with Respect to Bandwidth	48
25. DES Template Classification Performance with Respect to Bandwidth	48

List of Tables

Table		Page
1.	Factors and Levels of System Parameters	30
2.	Number of Observations for DES	36
3.	Key Guessing Entropy for DES	37
4.	Number of Observations for AES	39
5.	Key Guessing Entropy for AES	40

List of Abbreviations

Abbreviation		Page
SCA	Side Channel Analysis	1
EM	Electromagnetic	1
TEDA	Template-Enhanced Differential Analysis	2
NIST	National Institute of Standards and Technology	5
DES	Data Encryption Standard	5
AES	Advanced Encryption Standard	5
SPA	Simple Power Analysis	17
SEMA	Simple Electromagnetic Analysis	17
DPA	Differential Power Analysis	17
DEMA	Differential Electromagnetic Analysis	17
TA	Template Analysis	17
MOP	Measures of Performance	24

I. Introduction

1.1 Background

Side Channel Analysis (SCA) is a technique that extracts information from digital hardware. Unlike cryptanalysis, which targets mathematical weaknesses in encryption algorithms, SCA, when applied to a cryptographic system, targets unintended electromagnetic (EM) emissions produced by the hardware implementation of an encryption algorithm. Most often, the goal of analyzing information from cryptographic systems is to extract the encryption key used during data encryption. Quickly characterizing, analyzing and extracting information from the unintended EM emissions of cryptographic systems is important in the intelligence community because many methods used are time consuming and computationally intensive. Furthermore, with respect to protection, such research can lead to better protections for DOD encryption devices as well as improve techniques for exploiting adversary cryptographic devices.

1.2 Statement of Problem

Several SCA techniques can be found in the literature. They include techniques that target single or multiple bits of cryptographic information and other techniques that target algorithmic permutations of the desired cryptographic information. Template attacks [CRR02] are a type of SCA that compares the unintended EM emissions of a reference encryption device to emissions from a different but similar encryption device. The concept of a SCA technique that creates templates for individual keybits

is postulated as an effective technique in [ARRS05]. This research effort independently develops a comparable technique and names it the Single Keybit Template Attack (SKTA). The SKTA extracts cryptographic information from an encryption device by examining the hardware effects generated by the processing of a single keybit. This approach is different from other template attacks [CRR02, ARRS05] because it focuses on a single keybit rather than multiple keybits and it directly targets the encryption key instead of permutations of the key created by an encryption specific key schedule. This research examines the SKTA, compares it to the most powerful template attack, known as Template-Enhanced Differential Analysis (TEDA) [ARRS05], and determines its effectiveness. Specifically, this research determines the amount of information from an adversary device needed before the SKTA can extract the encryption key.

1.3 Thesis Scope, Limitations and Assumptions

This research validates the effectiveness of the SKTA technique. Therefore, it uses the same encryption device for characterization and classification of unintended EM emissions. Follow-up research to determine its effectiveness when classifying emissions from a different like-model device would be useful.

A limitation of this research lies in the uniqueness of the SKTA approach. Since the SKTA targets single encryption keybits, direct comparisons to other techniques are difficult. In any case, TEDA, a fundamentally different type of template attack, was used as a baseline. TEDA differs from the SKTA in that it targets multiple permuted representations of the keybits. However, the amount of collected data required before a successful key extraction is a performance metric both techniques have in common.

Another limitation is the use of a single class of encryption devices for generation

of EM emissions. The device under test is a 16-bit general-purpose microcontroller programmed to perform encryption algorithms. Other device types, such as Field Programmable Gate Arrays, smartcards and cellular phones, can further validate the SKTA's effectiveness. The performance trends seen with the microcontroller should be similar to trends in other device types.

1.4 Methodology Overview

The methodology for examining the SKTA begins by characterizing a reference cryptographic device performing encryption operations using random keys and random data. While encryptions occur, an EM probe is placed within 1mm of the device. The probe is connected to an oscilloscope that samples EM signals and saves the data for later analysis. The oscilloscope is triggered and programmed to save each encryption cycle in a unique data structure, which includes the EM signals, encryption key, input and output data. This data structure is referred to as a signal trace, the samples that comprise the signal are referred to as dimensions and the collection of signal traces gathered during the characterization stage are the training signals. Once the data is characterized, the classification stage begins by using the same device to perform similar encryptions except the key is fixed for all encryptions. Based on expectations developed from the characterization stage, the classification stage attempts to determine the key. The collection of signals traces gathered during the classification stage are the target signals traces. The minimum number of target signal traces collected during the classification stage before a key can be successfully extracted is recorded and compared to TEDA.

TEDA encryptions are performed on the same encryption device used for the SKTA encryptions. TEDA also incorporates a characterization stage followed by a classification stage. Therefore, it too will learn from emissions generated while

encrypting random keys with random data.

1.5 Thesis Chapters Overview

This chapter gives a brief overview of SCA, develops the problem statement, discusses experimental limitations and assumptions and introduces the experimental methodology. Chapter 2 provides SCA background and related statistical concepts. Chapter 3 presents the experimental methodology used to evaluate the SKTA. It also explains key performance metrics used to evaluate and compare the SKTA with TEDA. Chapter 4 presents the experimental results while Chapter 5 provides analysis and conclusions based on the results.

II. Background

Side Channel Analysis background is provided in this chapter. Topics include encryption standards, leakage models, correlation, classification theory, previous template attacks and measures of performance.

2.1 Encryption Standards

In Chapter 1, inputs and outputs of encryption algorithms were described simply as data. Now they are referred to with their proper names, plaintext and ciphertext. Encryption converts data to an unintelligible form called ciphertext while decryption converts the ciphertext back into its original form, called plaintext. Both encryption and decryption are accomplished using a key and a suitable encryption algorithm.

Encryption algorithms for use with sensitive data are approved by the National Institute of Standards and Technology (NIST). Two such standards are the Data Encryption Standard (DES) and the Advanced Encryption Standard (AES). Both standards are used to compare SKTA with TEDA and are described below. [NIS]

2.1.1 Data Encryption Standard.

DES is a federal information processing standard issued by NIST in 1977. [NIS77] A DES key consists of 64 bits of which 56 bits are used directly by the encryption algorithm. The other eight bits, not used by the algorithm, are for error detection and correction. The eight error detecting bits are set to odd parity based on the key bytes. DES encrypts 64 bits of data for each encryption cycle. As shown in Figure 1, DES incorporates a unique round key, K_n , to encrypt data during each of sixteen encryption rounds. Where $n \in \{1, \dots, N\}$ and N is the number of encryption rounds. Round keys are derived from the encryption key using a key permutation schedule

based on 48 bits of the encryption key. Therefore, any technique attempting to extract the encryption key must analyze two consecutive rounds, as the next round will use the remaining eight bits. Also shown in Figure 1, are two permutation functions labeled “initial permutation” and “inverse initial permutation”. Both permutations reorder input bits before passing them to the next stage of encryption. Boxes labeled $L_0...L_{15}$ and $R_0...R_{16}$ are the left or right halves of the bits from the stages that precede them, respectively. The operation of each circled “f” functions is shown in Figure 2. Figure 2 shows the combining of permuted key bits, depicted as K, with permuted plaintext bits, depicted as E. E “expands” 32 bits into 48 bits by repeating 16 of the bits. E and K are combined using the XOR function and input into look-up tables known as S-boxes. The eight 6-bit S-box inputs are the target for TEDA. DES was withdrawn as a federal information processing standard on 19 May 2005 after it was discovered a brute force attack could compromise it within a few hours [NIS].

2.1.2 Advanced Encryption Standard.

The successor of DES, the Advanced Encryption Standard was issued by NIST in 2001 [NIS01]. The AES algorithm is a symmetric block cipher that incorporates the Rijndael (pronounced Rhine-doll) encryption algorithm and has cryptographic keys sizes of 128 (“AES-128”), 192 (“AES-192”), and 256 (“AES-256”) bits. AES encrypts and decrypts data in blocks of 128 bits arranged in a 4x4 array of bytes. This array is called the *state*.

Figures 3 through 6 show the four data transformations used to encrypt data. The *SubBytes* transformation, Figure 3, uses S-boxes for non-linear byte substitutions and operates independently on each byte of the *state*. In the *ShiftRows* transformation, Figure 4, the bytes in the last three rows of the *state* are cyclically shifted over according to row index. The *MixColumns* transformation, Figure 5, operates on the *state*

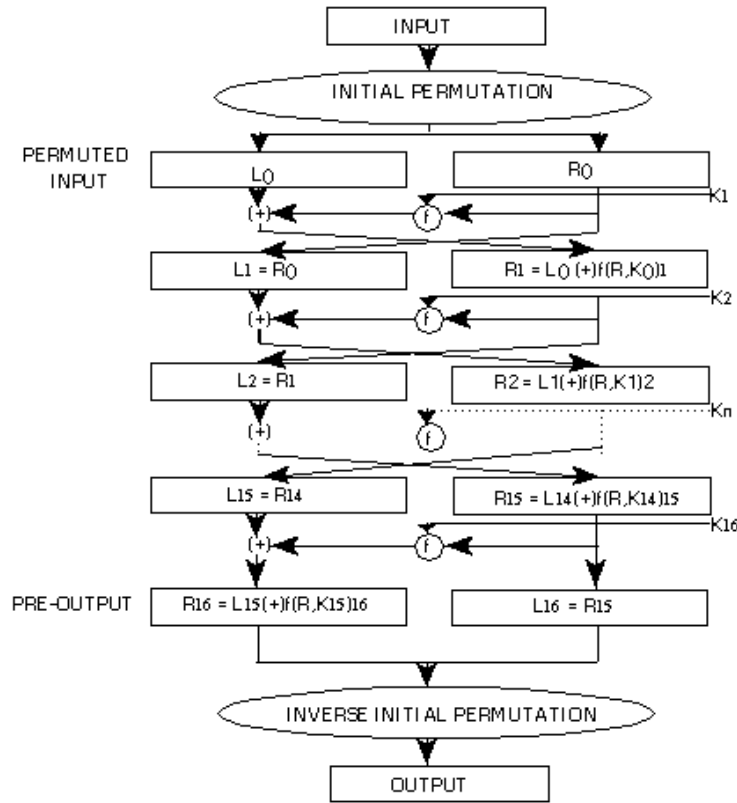

Figure 1. 16-Round DES Encryption Algorithm [NIS77]

column-by-column, treating each column as a four-term polynomial and multiplies it with another fixed polynomial. The *state* is then replaced by the resultant. In the *AddRoundKey* transformation, Figure 6, a round key is combined with the *state* using bitwise XOR operation.

The first round of encryption only performs the *AddRoundKey* transformation and last round only performs the *SubBytes*, *ShiftRows* and *AddRoundKey* transformations. The middle rounds perform all four transformations. AES uses a unique round key to encrypt data during ten, twelve or fourteen rounds of encryption, depending on key length. Round keys are derived using a key permutation schedule and are derived from all bits of the encryption key [DR98] .

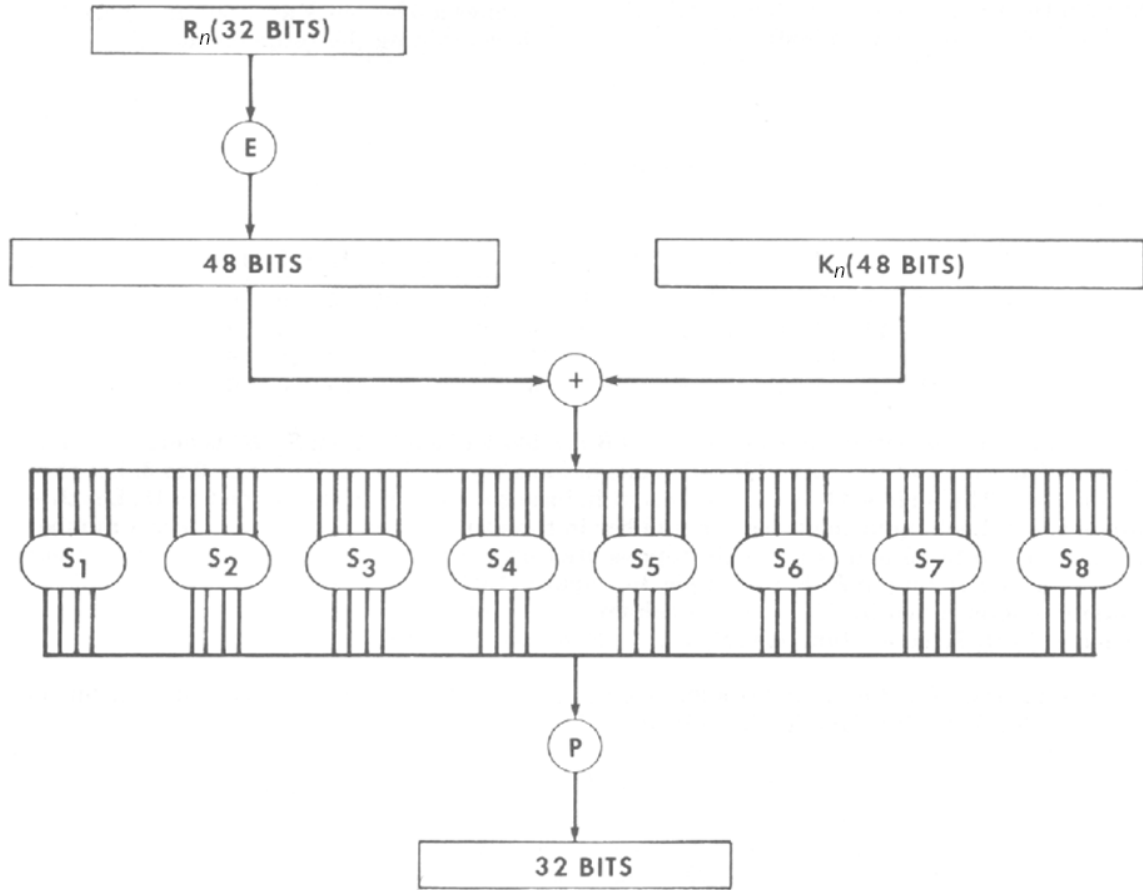

Figure 2. XORing of Permuted Plaintext E with Permuted Round Key K_n Before Entry Into 8 S-boxes [NIS77]

2.2 Hamming Distance Leakage Model

SCA uses leakage models to characterize the EM emissions generated by cryptographic devices since the power consumed by a microprocessor is proportional to its EM emissions and is therefore a good indicator of the data being processed [KJJ99]. Sample EM signal traces for DES and AES, collected by an EM probe, are provided in Figures 7 and 8. The amplitudes in the EM signals are directly proportional to the power consumption of the device [KJJ99]. Note the repetitive structure in the signal traces. The repetitions are equal to the number of encryption rounds in the respective algorithms.

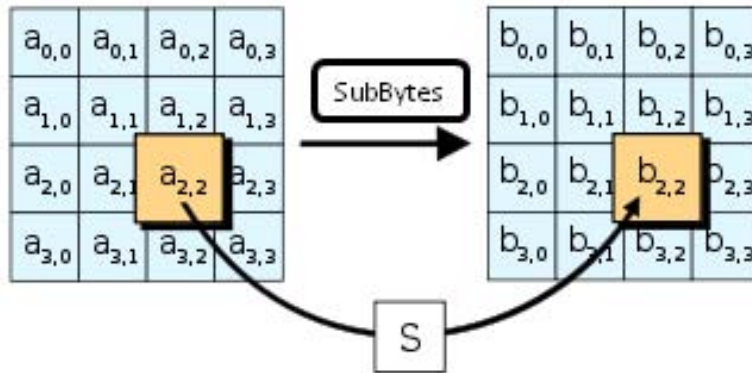

Figure 3. AES Substitute Bytes Transformation [NIS01]

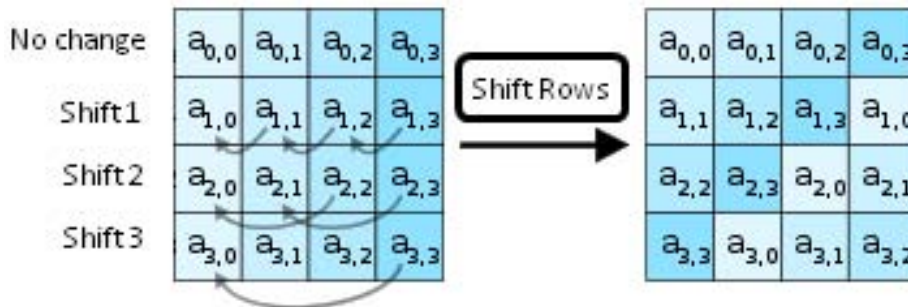

Figure 4. AES Shift Rows Transformation [NIS01]

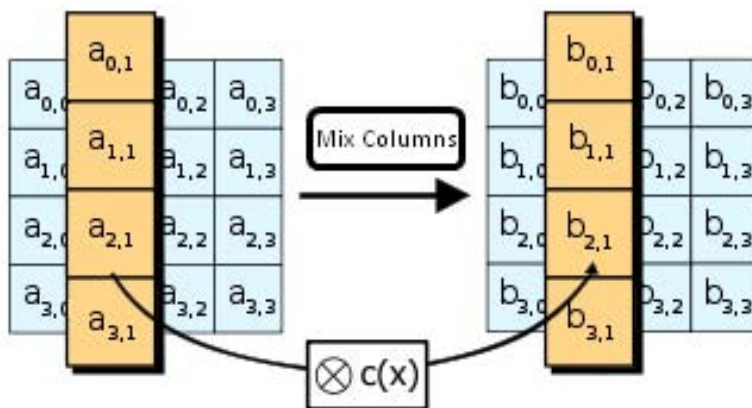

Figure 5. AES Mix Columns Transformation [NIS01]

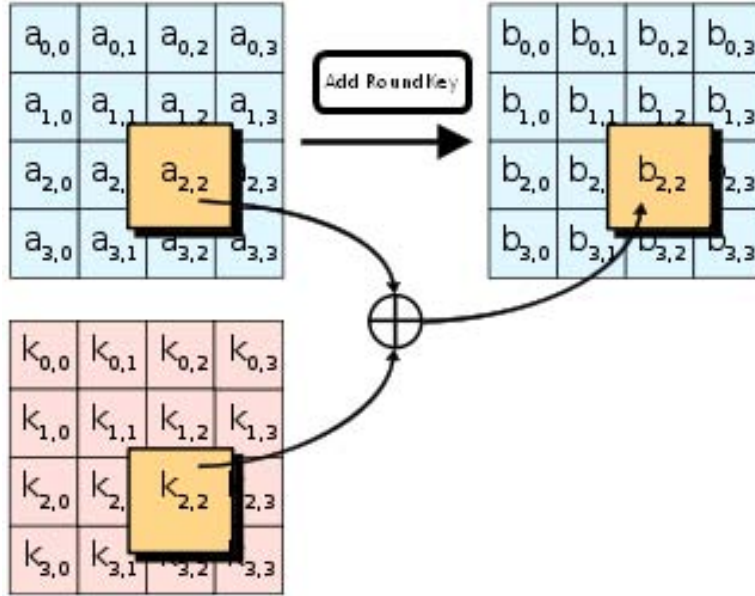

Figure 6. AES Add Round Key Transformation [NIS01]

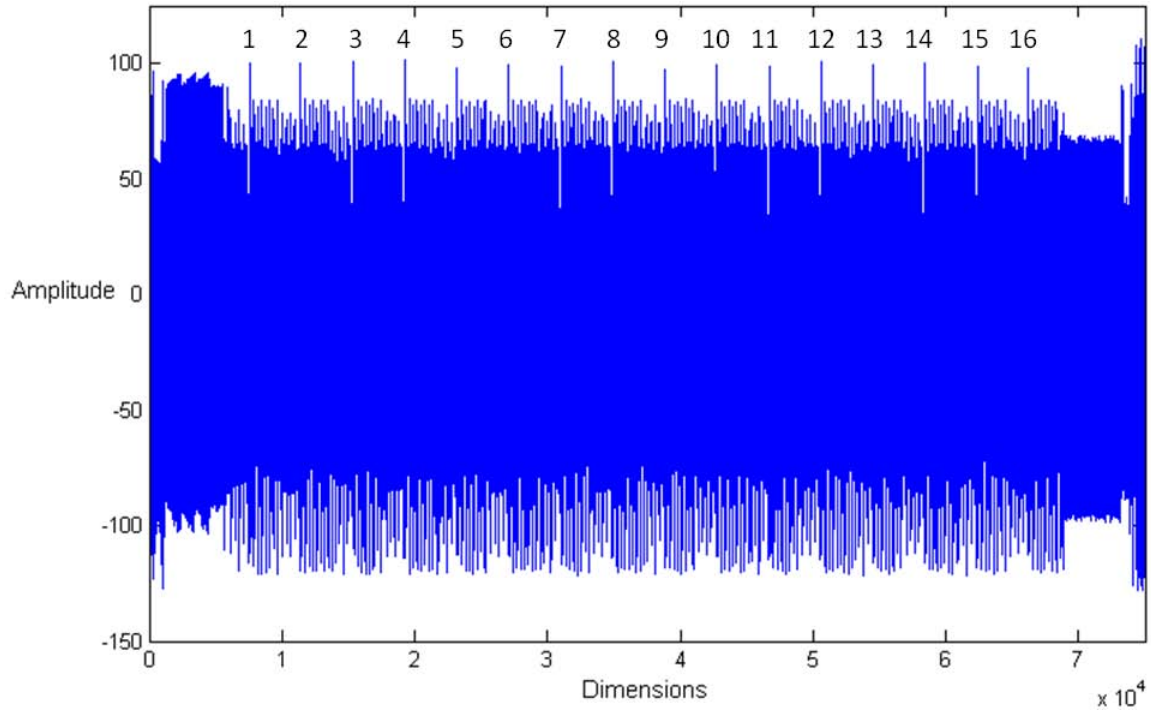

Figure 7. DES electromagnetic signal trace of 16 encryption rounds

The best and most often used leakage model in SCA is the *Hamming Distance* leakage model [MOP07] and is used to evaluate SKTA and TEDA is the *Hamming Distance* model. The *Hamming Distance*, HD, is the difference in *logic-high* bits

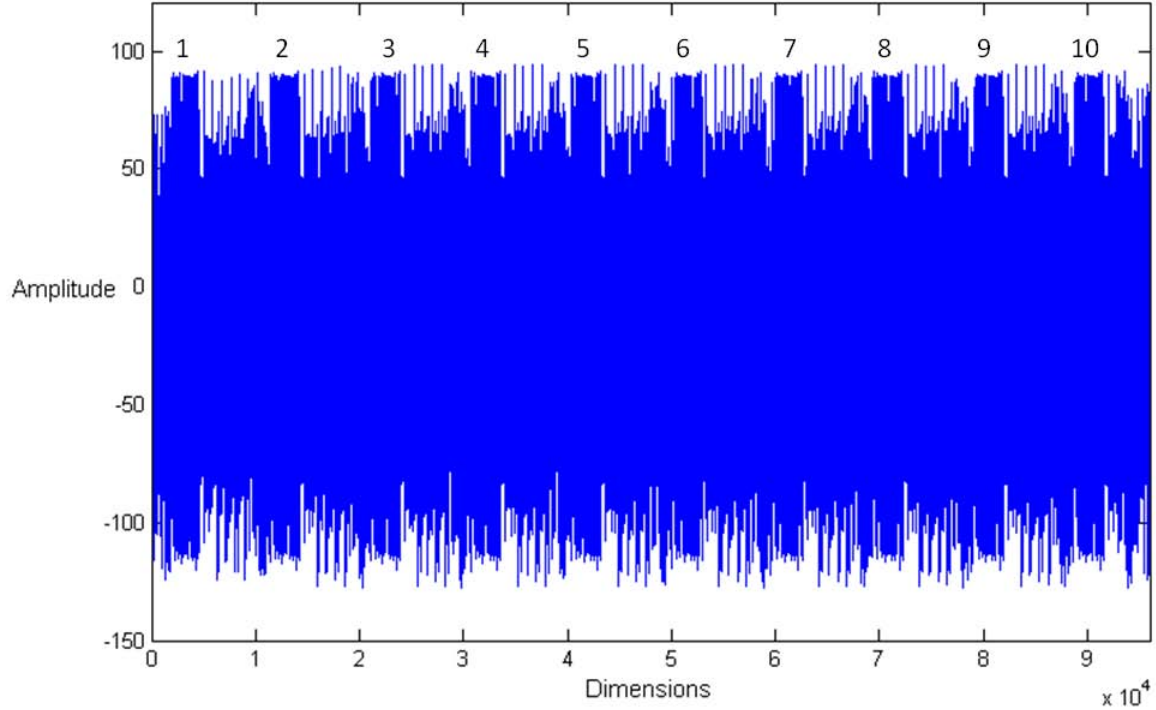

Figure 8. AES electromagnetic signal trace of 10 encryption rounds

between two binary data words. Closely related to the *Hamming Distance* model is the *Hamming Weight* model. The *Hamming Weight*, HW, of a binary data word is the number of *logic-high* bits in that data word. For example, data vectors $A = [00001111]$ and $B = [00000011]$ have *Hamming Weights* of four and two respectively. The *Hamming Distance* between the vectors is two.

As the *Hamming Distance* between two binary data words increases, the difference in power consumption used to process both words differs linearly as well. This difference in power consumption is evident in the EM signal traces in Figure 9 and 10. Figure 9 displays the visible *Hamming Distance* between two traces which are the means of several thousands of signal traces with *Hamming Weights* of “0” and “1”. In this case, the two *Hamming Weights* represent the two possible values for a bit, which is the target used in the SKTA experiments. Figure 10 displays the visible *Hamming Distances* between the means of several thousands of signal traces

corresponding to the 64 possible values for a 6-bit S-box input which is the target for the TEDA experiments.

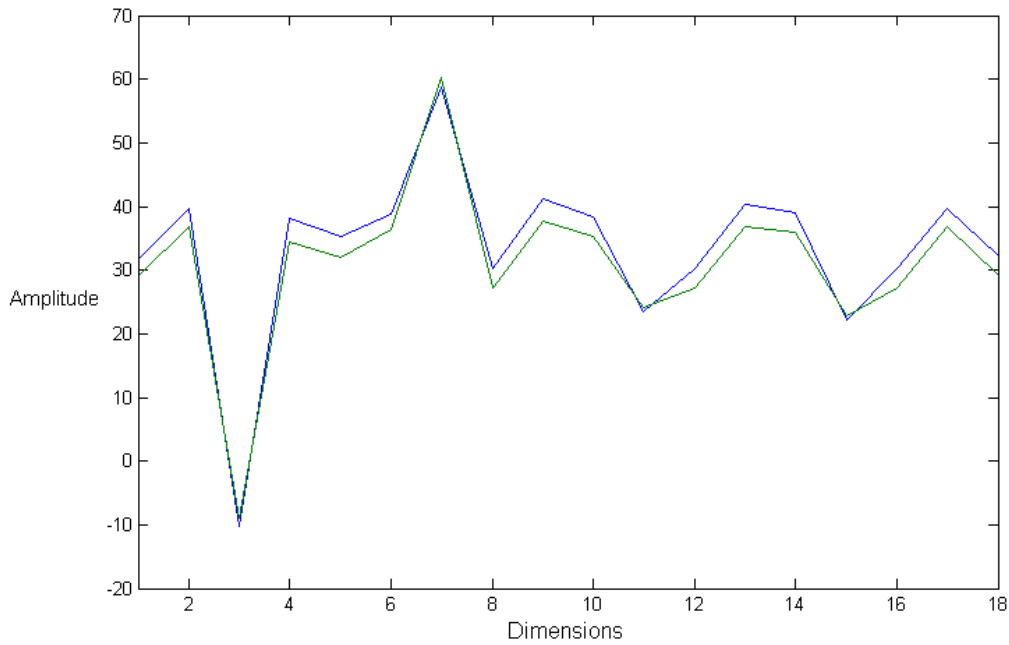

Figure 9. Visible Hamming distances of mean signal traces of one keybit for values “0” and “1”

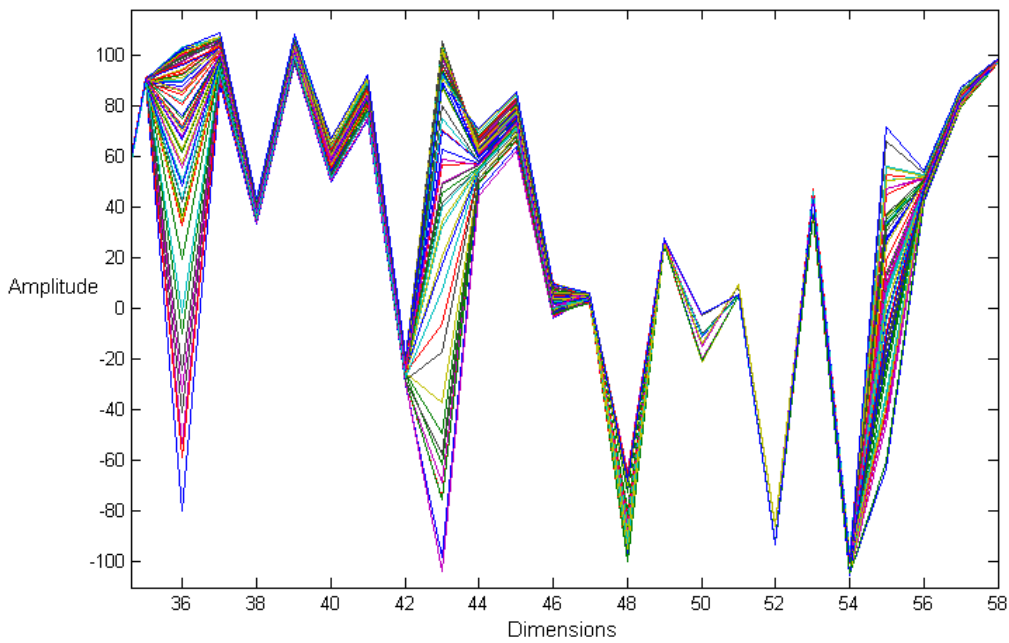

Figure 10. Visible Hamming distances of mean signal traces for 6-bit S-box inputs “0” through “63”

2.3 Statistics Background

Once the leakage model is selected, statistical techniques like Pearson's correlation coefficient and Baye's rule to facilitate the template attack. Pearson's correlation coefficient finds dimensions in the signal trace that are "worthy" of further analysis. By only focusing on the worthy points, the number of dimensions needed to process is drastically reduced. Baye's rule allows previous classification decisions to be updated with new knowledge, thus improving the probability of an overall correct classification. Both concepts are discussed below.

2.3.1 Correlation.

When analyzing EM signal traces for DES and AES, shown in Figures 7 and 8 respectively, the amount of data to process is important. One technique to reduce the computational processing burden is to only process the dimensions along the signal trace that are correlated to keybit values for the SKTA or to S-box input values for TEDA. Pearson's correlation coefficient,

$$\rho_{XY} = \frac{Cov(X, Y)}{\sqrt{(Var X)(Var Y)}} \quad (1)$$

produces a dimensionless quantity that lies between 1 and -1 which measures the linear relationship between two random variables, X and Y. A coefficient near 1 or -1 indicates a strong linear relationship while a coefficient near zero indicates a very weak relationship.

When a keybit or S-box input is correlated with the DES and AES signal traces, a vector of correlation coefficients for each dimension is generated. The correlation coefficients, from Figures 7 and 8 are plotted in Figures 11 through 14.

Figure 11 shows the correlation between DES signal traces and one encryption

keybit using SKTA. Note that there are 13 peaks which correspond to the number of instances the particular keybit is accessed in the DES encryption algorithm. There are also 75,000 dimensions in the trace. Using Pearson's correlation coefficient as a filter, the template classification process need only analyze the 13 dimensions were the peaks are noticeably above the noise floor and ignore the remaining 74,987 dimensions. Figure 12 is a similar plot for the AES algorithm. There are only three peaks along the entire AES signal trace correlated to the particular keybit. Obviously, processing only three dimensions is trivial in terms of computer processing time. However, Figure 12 also indicates most of the trace has very little correlation to the keybit.

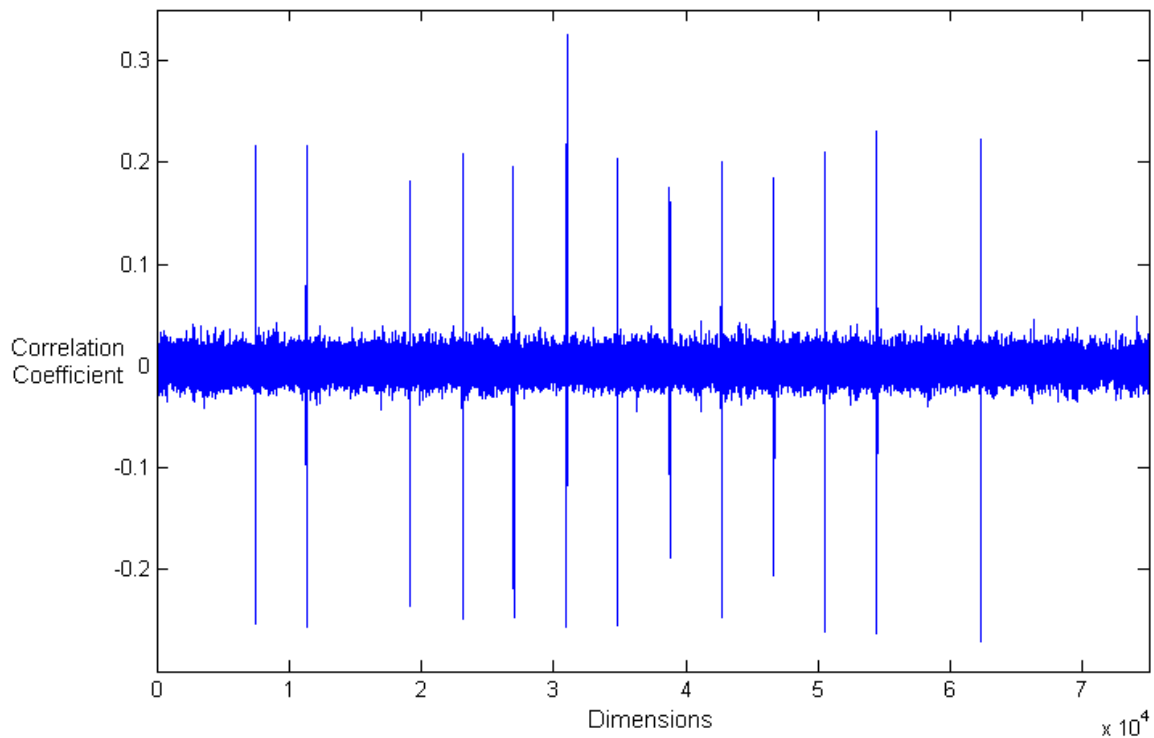

Figure 11. DES Correlation Between Signal Trace and Keybit

For TEDA, Figure 13 is the correlation between DES signal traces and the 6-bit S-box input. In this example, an S-box from the first round of encryption is targeted. So the high correlation peaks predominate towards the beginning of the trace. Note how the peak correlation coefficients between signal traces and S-boxes

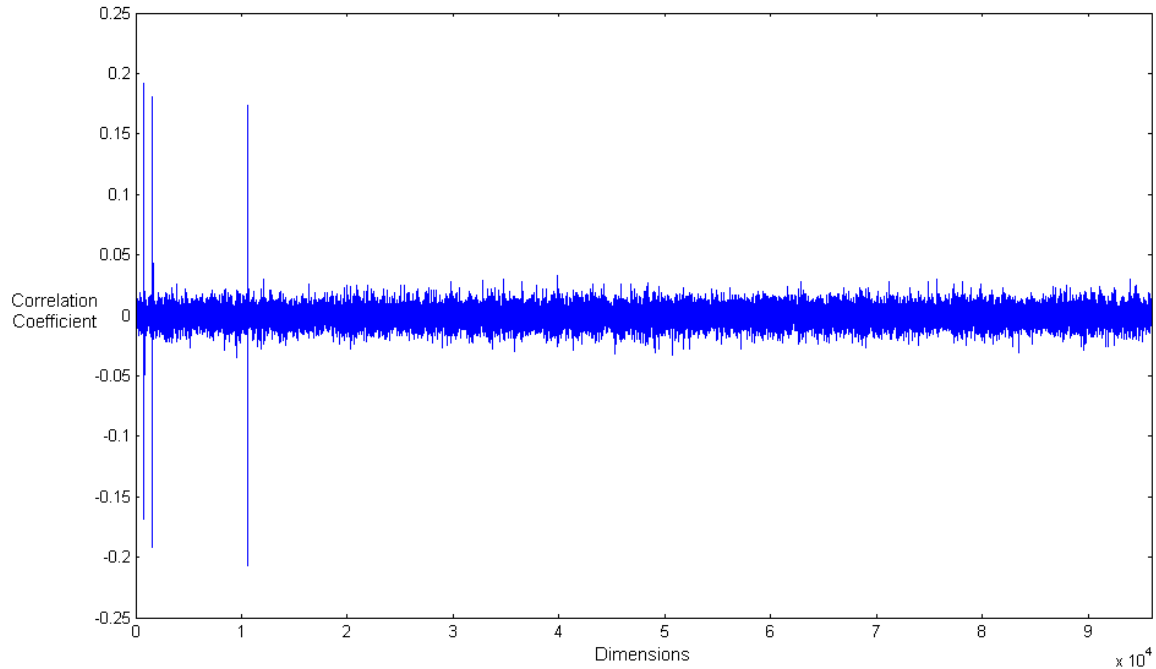

Figure 12. AES Correlation Between Signal Trace and Keybit

is approximately 0.6 in Figure 13 and approximately 0.2 for signal traces and keybits in Figure 11. This indicates better template classification results will be achieved when attacking S-box inputs. Figure 14 is the correlation between AES signal traces and the 8-bit S-box inputs. With a peak correlation coefficient of approximately 0.6, compared to 0.2 in Figure 12, better template classification performance is expected when attacking S-box inputs.

2.3.2 Baye's Rule.

Classification of target signal traces employs Bayesian decision theory, also known as Baye's rule, because it is optimal for the minimization of classification error probability [TK09]. Baye's rule incorporates prior knowledge along with a given set of current observations to make statistical inferences, which are given as posterior probabilities. The prior knowledge, or prior probabilities, could come from observational data, previous comparable experiments or from engineering knowledge [Cor06]. For

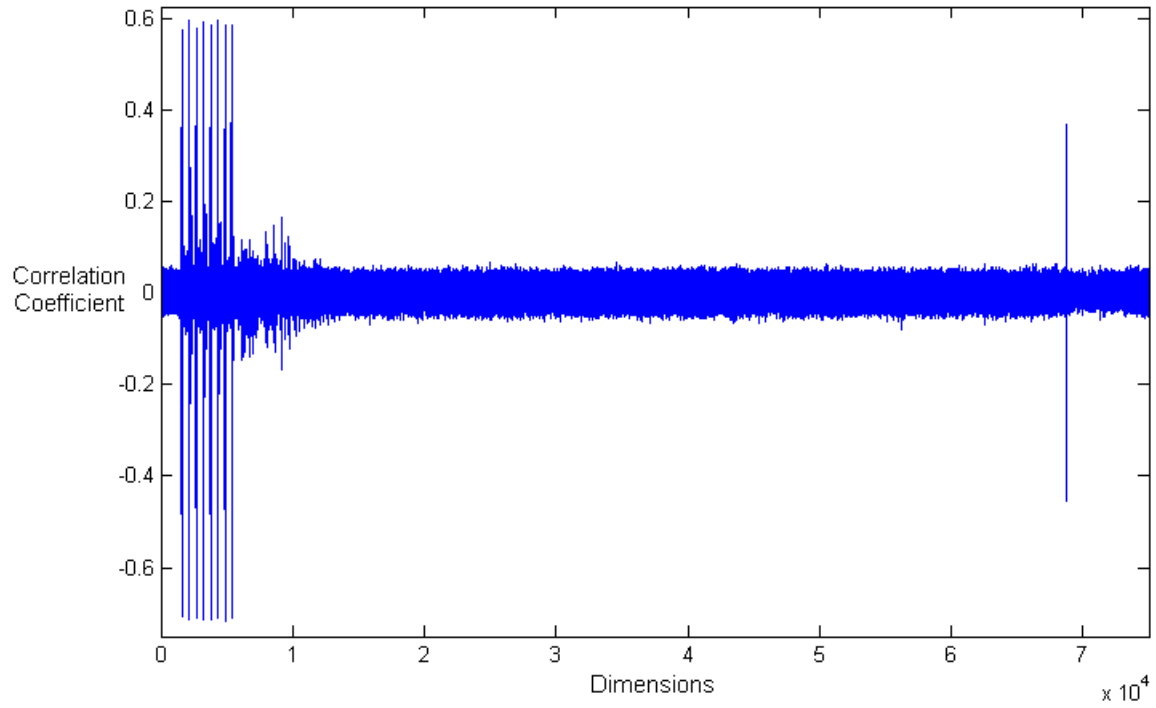

Figure 13. DES Correlation Between Signal Trace and S-box Input

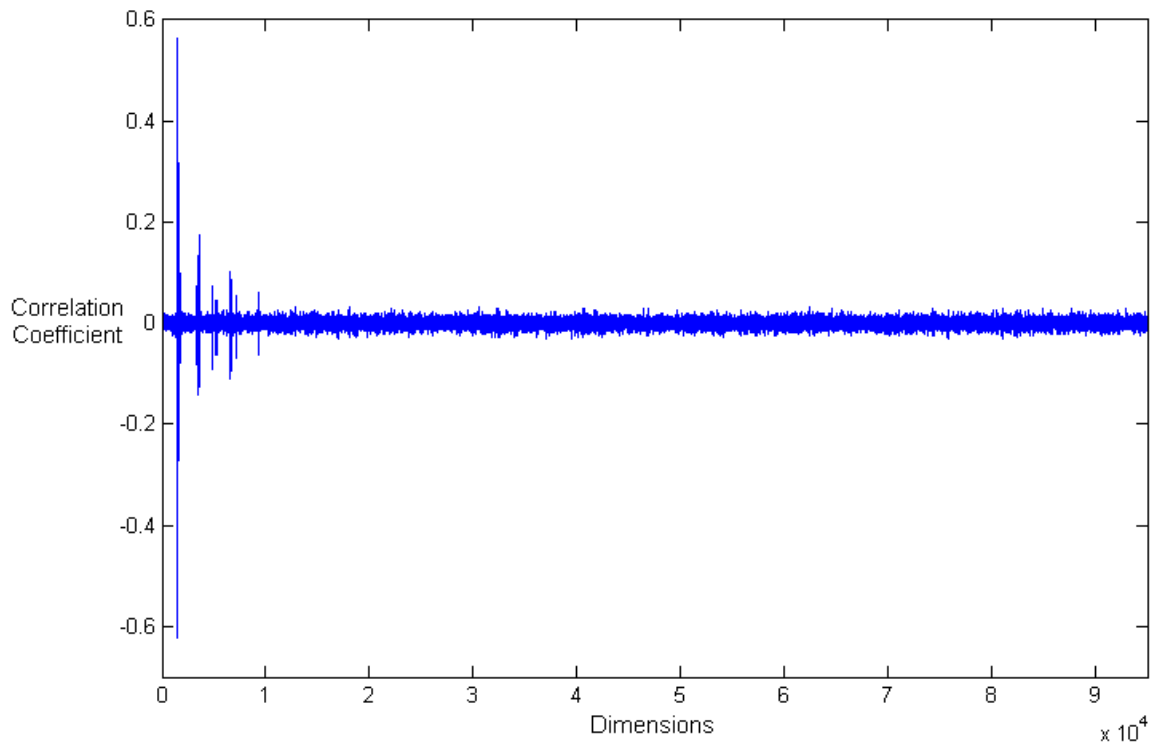

Figure 14. AES Correlation Between Signal Trace and S-box Input

SKTA, the initial prior probabilities are the probability of observing the two possible values for one keybit, both 0.5. For TEDA, when evaluating DES, the initial prior probabilities for the 6-bit S-box inputs are $1/2^6 = 0.0156$. For AES, the initial prior probabilities for the 8-bit S-box inputs are $1/2^8 = 0.00391$.

Given multiple target signals traces from the encryption device, Baye's rule can be applied iteratively to improve the overall classification success. After each new target signal trace is classified, the prior probabilities are updated to equal the posterior probabilities provided by that classification. That is, the posterior probability becomes the prior probability for the next classification. As more observations are made, a more confident decision can be made about the trends occurring in the classification's posterior probabilities. As expected, achieving a higher level of confidence requires more observations.

The general formula for Baye's Theorem is

$$P(A|B) = \frac{P(B|A)P(A)}{P(B)} \quad (2)$$

where $P(A|B)$ is the posterior probability, $P(A)$ is the prior probability of A which is independent of B, the likelihood or $P(B|A)$ is the conditional probability of B given A, and $P(B)$ is the prior probability of B [Kay98].

2.4 Types of Side Channel Analysis

There are several variants of SCA, including Simple Power Analysis (SPA), Simple Electromagnetic Analysis (SEMA), Differential Power Analysis (DPA), Differential Electromagnetic Analysis (DEMA) and Template Analysis (TA).

2.4.1 Simple Power and Electromagnetic Analysis.

SPA is a visual analysis of power-based signal traces collected via a current probe in series with the microprocessor power line while performing an encryption operation. This “simple” inspection visually looks for characteristic patterns in the signal traces that represent key dependent operations such as branch or jump instructions. Once these patterns are found, the key value can simply be “read” from the signal traces. In general, only one or a small number of traces are collected. The same methodology is true of SEMA except that EM traces are analyzed instead of power consumption traces. These EM traces are typically collected with a near-field EM probe or antenna. SEMA has a distinct advantage over SPA because EM signals can be collected without physically contacting the microprocessor [MOP07].

2.4.2 Differential Power and Electromagnetic Analysis.

DPA [KJJ99] and DEMA [QS01] are analogous to SPA and SEMA with respect to signal collection techniques. However, DPA and DEMA represent a more powerful statistical approach to SCA. In differential analysis, whether on power or EM traces, hypotheses on intermediate values, such as S-box inputs, of an encryption algorithm are correlated with the instantaneous power consumption seen in the target signal traces. In differential analysis, the plaintext or ciphertext is required to develop the hypotheses needed to perform correlation. DPA and DEMA attacks are focused on the first or last rounds of encryption because the unpermuted plaintext and ciphertext are accessible, respectively. DPA and DEMA generally train with a large amount of traces varying from several thousand to a million or more.

2.4.3 Template Analysis.

Template Analysis [CRR02], or template attacks, is a two-stage side-channel attack performed using a reference device that is identical or nearly identical to a target device. The first stage, known as the characterization or profiling stage, characterizes the EM signal traces of the reference device by creating a template for the operations or data values of interest. Several thousand signal traces are used to create each template, which consists of a mean trace, and a probability density of the noise. The distribution of the noise is assumed to be key-dependent. Thus, the profiling stage creates covariance matrices for each operation or data values of interest. In the next stage, known as the classification stage, a target signal trace acquired from an encryption device is iteratively compared to the templates to find which templates best match the target signal trace. Selecting templates that best match the target trace can lead to the discovery of the entire encryption key or to a reduced set of possible keys.

2.4.3.1 Template Construction.

In the characterization/profiling stage, a large number of signal traces, t , collected from the reference encryption device are used to build a template database. In the original template work [CRR02], a template $T(\hat{\mu}_i, \hat{\Sigma}_i)$ is comprised of the following estimators

$$\hat{\mu}_i = \frac{1}{k} \sum_{j=1}^k t_{i,j} \quad (3)$$

and

$$\hat{\Sigma}_i = \frac{1}{k-1} \sum_{j=1}^k (t_{i,j} - \hat{\mu}_i)(t_{i,j} - \hat{\mu}_i)^T \quad (4)$$

where $\hat{\mu}_i$ is the mean trace for the operation or data value(s) of interest, $\hat{\Sigma}_i$ is the corresponding noise covariance matrix, where i is the uniquely created template where

$i \in \{1, \dots, n\}$, n is the total number of templates, j is the index to all training traces, $j \in \{1, \dots, k\}$, and k is the number of training traces [CRR02, HTM09].

2.4.3.2 Template Classification.

In the template classification stage, individual target signal traces are compared to the templates. If necessary, the target signal trace is first be preprocessed in the same manner that the template generation traces were processed. For each of the possible templates, the probability of the signal trace corresponding to a given template is calculated using

$$P(t|h) = \frac{1}{\sqrt{(2\pi)^n \det(\hat{\Sigma}_i)}} \cdot e^{-\frac{1}{2} (\hat{\mu}_i - t)^T \hat{\Sigma}_i^{-1} (\hat{\mu}_i - t)^T} \quad (5)$$

where t is the target trace and h is the keybit hypothesis associated with a specific template $T(\hat{\mu}_i, \hat{\Sigma}_i)$.

These probabilities measure how well the templates correspond to the target signal trace. The template with the highest resulting probability is the most likely candidate. Because each template is associated with a keybit hypothesis or S-box input hypothesis, it is possible to derive the key used in the target encryption device.

If multiple adversary traces are available, then Baye's rule

$$P(h_j|t) = \frac{P(t|h_j) \cdot P(h_j)}{\sum_{i=1}^K (P(t|h_i) \cdot (h_i))} \quad (6)$$

where $P(h_j|t)$ is the probability of a keybit hypothesis given a trace t which is dependent upon the prior probability $p(h_i)$ and the probability $p(t_i|h_i)$ of (5) can be iteratively applied for each target trace to increase the confidence in the template selected using (5) [Kay98, OM07].

Figure 15 demonstrates an iterative use of Baye's Rule. Note that with fewer

observed target signal traces, several key hypotheses are possible classification candidates. As the number of observed traces increases, one key hypothesis candidate, shown in blue, converges to a probability of one while all others converge to zero.

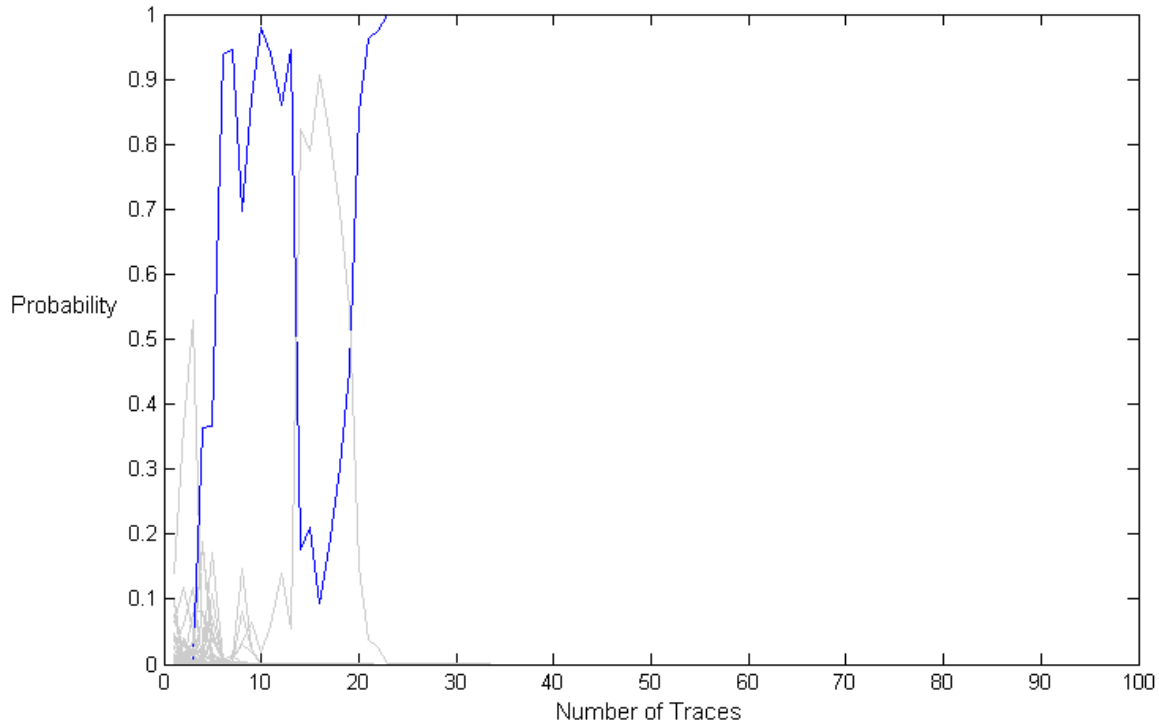

Figure 15. Evolution of key hypothesis probabilities as the number of observed traces increases

2.5 Template Attack Techniques

Both SKTA and TEDA use the same template creation/classification techniques explained in Sections 2.4.3.1 and 2.4.3.2; their differences are described below.

2.5.1 Single Keybit Template Attack.

SKTA is a unique template attack technique that creates two templates for every encryption keybit, 112 and 256 templates for DES and AES respectively. It associates one or more target signal traces to the templates to extract the encryption key. SKTA

is similar to traditional template attacks with three notable exceptions. First, SKTA directly targets the encryption key instead of algorithmic permutations the encryption key. Second, SKTA creates templates from single keybits rather than multiple keybits. Third, SKTA does not require any cryptographic knowledge about the target signal traces, such as the plaintext or ciphertext used in the creation of the target signal traces.

The third difference provides a significant advantage over TEDA. Since TEDA requires plaintext or ciphertext knowledge about each trace, each trace must be evaluated separately. For SKTA, no plaintext or ciphertext knowledge is required. This allows target traces to be averaged together before classification. Obviously, as more target traces are averaged together the true mean of target signal trace develops. Once the true mean of the signal trace is classified, adding more target signal traces to the true mean will not improve classification results.

2.5.2 Template Enhanced Differential Analysis.

TEDA combines template attacks with traditional differential analysis techniques. It is capable of targeting S-box inputs or outputs while using either *Hamming Distance* or *Hamming Weight* leakage models. If targeting the inputs for one S-box, TEDA creates templates for every possible input value, which for DES and AES is 64 and 256 templates, respectively. Since DES has eight 6-bit S-boxes per encryption round and two consecutive rounds use all keybits, 1,024 templates are required for analysis. AES has 16 8-bit S-boxes and uses all keybits in the first encryption round. Therefore, 4,096 templates are required for analysis. In addition, all forms of differential analysis, including TEDA, require cryptographic knowledge about the target signal traces to function, in this case, the plaintext or ciphertext associated with each target signal trace.

2.6 Summary

This chapter describes background about SCA techniques. Leakage models are explained and justified. Correlation and Baye's rule were described. In addition, the statistical basis of template creation and classification were provided. Finally, previous fundamental SCA techniques are highlighted including template attacks that are the basis of the two template attack techniques evaluated in this research. Chapter 3 describes the experimental methodology used to evaluate and compare the SKTA with TEDA.

III. Methodology

3.1 Problem Definition

3.1.1 Goals.

The goal of this research is to determine the effectiveness and the best usage scenario of SKTA as a stand-alone encryption key extraction method. This goal can be expressed in more detail with the following four investigative questions:

1. Is the Single Keybit Template Attack (SKTA) effective?
2. Under what configuration(s) is SKTA most effective?
3. For specific measures of performance, how effective is SKTA compared to Template Enhanced Differential Analysis (TEDA)?
4. Under what conditions and scenarios is SKTA preferred over TEDA?

3.1.2 Hypotheses.

The determination of SKTA's effectiveness is based on examining several configurations. When applicable, configurations for both template attack techniques are implemented using a PIC microcontroller, the Advanced Encryption Standard (AES) or Data Encryption Standard (DES), in time, frequency or wavelet domains and with several data bandwidths. For all experimental configurations, the number of target device observations and key guessing entropy measure the performance of both template attack techniques. These measures of performance (MOP) are described in section 3.5.

Based on the above experimental configurations, prior research in template attack techniques, the measures of performance and previous experiments, the following hypotheses are formulated:

- When evaluating the DES algorithm, SKTA should require fewer target signal traces to extract a key and have a higher key guessing entropy percentage because more correlation peaks are available to SKTA than to TEDA (see Figures 11 vs. 13). The DES algorithm operates on encryption keybits 12-15 times during each encryption cycle whereas the S-box inputs, required by TEDA, are only accessed once.
- When evaluating the AES algorithm, SKTA should require more target signal traces to extract a key and have a lower key guessing entropy percentage than TEDA because AES generates fewer correlation points for SKTA to examine. Additionally, the correlation coefficients for the peaks are lower for a keybit attack than for an S-box attack. TEDA overcomes these drawbacks by using the plaintext associated with each target signal trace to extract a key (cf. Figures 12 and 14).

Validating the above hypotheses is sufficient to answer the four investigative questions and the research goal.

3.1.3 Approach.

To determine SKTA's effectiveness and prove or disprove the hypotheses, several replications of device EM signal acquisitions are collected for four experimental configurations. Each experiment has two measures of performance. Overall, four experiments and eight measurements are required for a full factorial research effort with only one replication.

To avoid sporadic use of collection equipment, five replications of EM signal traces, representing training and target sets, are collected for DES and AES encryptions. Once collected, the two types of signal traces, representing DES and AES, are evaluated with SKTA and TEDA.

Finally, MOPS are collected and evaluated to ensure an appropriate amount of replications are collected.

3.2 System Boundaries

The System Under Test (SUT), graphically depicted in Figure 16, is the Key Extraction System (KES) which is comprised of the Component Under Test (CUT), an encryption device, data collection system and the data analysis computer station. The CUT is the two template attack techniques discussed earlier.

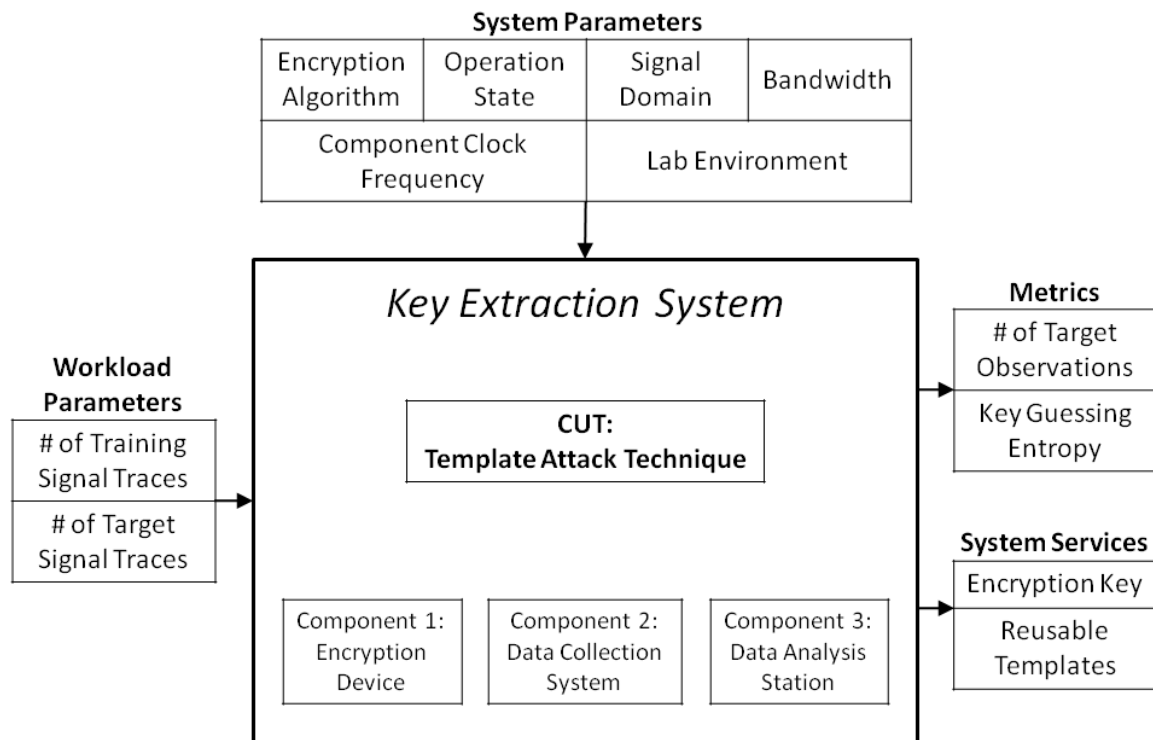

Figure 16. Key Extraction System

This research is limited to the encryption device available. However, 16-bit general-purpose microcontroller devices are highly representative of devices commonly used in data encryption. Data bandwidth is limited by the amount of memory and processing capacity in the data analysis computer station. However, the data analysis computer station is capable of processing any data bandwidth commonly seen in SCA

literature, in a reasonable amount of time.

3.3 System Services

The Key Extraction System provides two services. The first service is the extraction of the encryption key from the target signal traces captured by the system. The second service is the creation of multiple reusable templates that are capable of extracting keys from traces collected from encryption devices similar to the device used to create the templates.

3.4 Workload

The Key Extraction System has two workload parameters: the amount of training signal traces and number of target signal traces. The number of training signal traces is fixed at 100,000 for all experiments. The number of target signal traces is increased until a key is extracted or the performance of the template classifier ceases to improve.

3.5 Measures of Performance

Performance of SKTA and TEDA is evaluated using two measures of performance: the number of required target device observations and key guessing entropy. Each metric is described below.

- The number of target device observations is the number of signal traces the template classifier requires to produce a classification with a posterior probability of one. The maximum number of observations needed for each keybit classification in SKTA, or each S-Box input classification in TEDA, is used as the overall result for the performance metric. Requiring fewer target signal traces to extract a key is more desirable.

- Key guessing entropy [FXSY09] is the percentage of correct keybits extracted by the template attack. A percentage is used because DES and AES have different key lengths. Having a higher key guessing entropy percentage means more keybits are extracted and is therefore better than having a lower key guessing entropy percentage.

Calculating the key guessing entropy begins with sorting the keybit posterior probabilities provided by the template classifier. Starting from the lowest probability, iterate each successive keybit until the correct key is discovered. To determine if the correct key is discovered in a real-world scenario, a plaintext-ciphertext pair is required to test the key. For these experiments, the key is known apriori. To generate the key guessing entropy percentage, (7), the number of keybits iterated, REQ_{KI} , until the correct key is found is subtracted from the total number of keybits, N_K , and divided by the total number of keybits.

$$GuessingEntropyPercent = \frac{N_K - REQ_{KI}}{N_K} \quad (7)$$

3.6 System Parameters

The following are the system parameters for the Key Extraction System.

- **Encryption Algorithm** - An encryption algorithm converts data to an unintelligible form called ciphertext while decrypting the ciphertext converts the data back into its original form, called plaintext. Both encryption and decryption are accomplished using a key and a suitable encryption algorithm. An encryption algorithm is required to test each template attack's ability to extract a key.
- **Signal Domain** - The signal domain is the manner in which data is repre-

sented. Switching between domains requires the use of an appropriate transform. Transforming to different domains can alter the way in which data is represented and can also change what information is presented. Varying signal domains tests a template attacks ability to extract keys from different representations of data. A pilot study determined the wavelet domain provides optimal results when considering performance and computational workload. Details of this pilot study are provided in Appendix A.1.

- **Signal Bandwidth** - The signal bandwidth indicates the amount of information gathered for each signal trace during collection. Determining a sufficient bandwidth required for the template attacks can lead to more efficient data analysis and less workload for the data analysis computer station. Another pilot study determined a bandwidth in the range of 200 - 500 MHz provides optimal results when considering performance and computational workload. Details of this pilot study are provided in Appendix A.2.
- **Component Clock Frequency** - The encryption device is operated at a typical system clock frequency and does not vary during experimentation. Although it is possible to vary clock frequencies, the data collection system imposes an upper bound on the clock frequency to avoid signal aliasing. Once the clock frequency in a target signal trace is determined, the clock frequency of the reference encryption device and the signal processing parameters of the data collection system are set accordingly.
- **Operation State** - Possible operation states include the transition-state and steady-state. When the encryption device is first powered on, it begins operation in the transition state. The transition-state is characterized by a relatively large change in device temperature while computations occur. According to

preliminary measurements of the encryption device, the transition-state typically lasts 10-15 minutes before the device transitions into the steady-state. The steady-state is characterized by relatively small changes in device temperature during operation. For all experiments, the steady-state of operation is used to generate results with higher precision.

- **Lab Environment** - The lab environment is in an office-like environment which contains RF-based test equipment. To ensure low contamination of the data, experiments are conducted when RF equipment is off and cell phones are not within five feet of the encryption device.

3.7 Factors

The following tables list the experimental factors and levels that are further discussed below.

Table 1. Factors and Levels of System Parameters

Encryption Algorithm	Template Attack
DES	SKTA
AES	TEDA

- **Encryption Algorithm** - The encryption algorithms are DES and AES-128. These two algorithms are chosen because both are or have been the standard approved by NIST to encrypt sensitive data. Triple-DES [NIS99], AES-192 and AES-256 were not considered because they are essentially enhancements of DES and AES-128 and do not represent a fundamentally different type of encryption scheme. A significant difference between DES and AES is that the DES key is accessed during all 16 rounds of encryption while the AES key is

only accessed in the first round. The remaining rounds of AES encryption use permuted representations of the key that removes any correlation between that round's key and the original key. AES is expected to have worse template attack performance compared to DES because the original keybits are only accessed once while the DES keybits are accessed 12-16 times throughout the encryption.

- **Template Attack** - The template attacks are the Single Keybit Template Attack and Template Enhanced Differential Analysis. Both template attacks are evaluated with DES and AES. TEDA was chosen as the only template attack to compare against SKTA because it is the most powerful template attack technique [OM07, RO04].

3.8 Evaluation Technique

Direct measurement of the encryption device is the evaluation technique for this research. Analytical models are not feasible due to a lack of accessibility to proprietary SPICE models. Simulations are also not applicable because they only create signal traces generated with fixed key and random plaintext. Both SKTA and TEDA experiments require signal traces generated from random keys and random plaintext. Therefore, the best validation method is to compare experimental results with results using similar configurations in other template attack research [ARRS05, CRR02, HTM09]. Results are not expected to be identical because devices, bit-widths and signal collection techniques vary amongst researchers. However, performance trends should be consistent.

3.9 Experimental Configuration

A description of the Key Extraction System setup, see Figure 17, and analysis methodology used herein is provided below - including setup of the device under test

and signal collection.

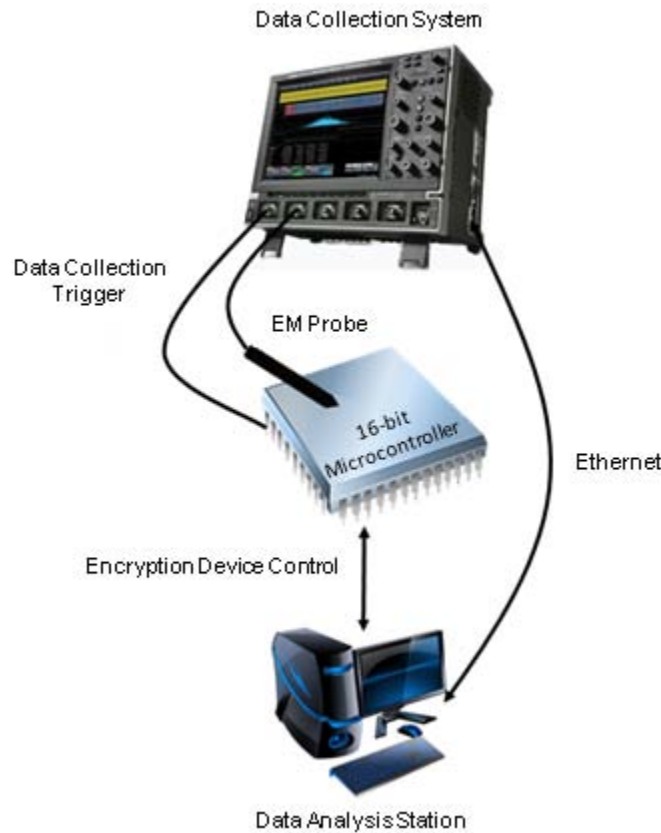

Figure 17. Key Extraction System Setup

3.9.1 Experimental Setup.

For all experiments, unintentional EM emissions of a 16-bit PIC microcontroller (PIC24FJ48GA002) manufactured by Microchip Technology, Inc. is evaluated [MTI10]. The PIC device is representative of the low cost microcontrollers used in a variety of real-world commercial security applications such as garage door openers and remote keyless entry systems [PEK⁺09] and is easy to obtain through normal commercial channels.

For device control and measurement, the microcontroller is mounted on a Microchip 16-bit 28-pin Starter Development Board [MTI08]. The circuit board is fixed in place on a measurement table using a custom fitted jig to minimize any lateral

movement of the device during or between collections. The board was chosen for its clean layout which includes only a small number of on-board components, thus providing a relatively low-noise environment for collection. Where possible, on-board peripherals (LEDs and potentiometer) are disconnected via jumpers to further reduce any RF noise induced by their operation. The circuit board is powered from a standard lab DC power supply (Agilent E3631A) to reduce effects of any uncontrolled supply voltage fluctuations.

An on-board PIC18 microcontroller, used to control the USB port for emulation of an RS232 serial interface, could not be disabled. This second microcontroller was active during all collections and is physically located less than an inch from the primary microcontroller of interest.

The development board provides an external 7.37 MHz crystal oscillator signal to the microcontroller. The microcontroller is configured with the on-board clocking system to generate an internal operating frequency of $f_{OSC} = 29.48$ MHz from this signal [MTI10].

3.9.2 Signal Collection.

Unintentional EM emissions from the microcontroller are collected using a near-field probe (1 GHz bandwidth) connected to a Lecroy 104-Xi-A oscilloscope as shown in Figure 17. The probe acts as an antenna to receive the unintentional emissions from the device under test, and does not directly contact the chip. The oscilloscope has a maximum input bandwidth of $W_I = 1$ GHz and a maximum sample rate of $f_S = 10$ GSa/sec. All data presented here is collected at a sample rate of $f_S = 500$ MSa/sec and a bandwidth of $W_C = 200$ MHz.

The near-field probe is mounted on a computer-controlled motorized XYZ table for consistent placement of the probe relative to the device under test. The initial probe

position was established by performing a two-dimensional scan of the surface of the microcontroller as it repeatedly executed a sequence of encryption operations. The results of the scan were processed with a bandpass filter and analyzed to determine the location of maximal EM energy in the band corresponding to the known internal clock frequency of $f_{OSC} = 29.48$ MHz. The probe and relative device positions remained fixed for all collections.

To improve collection efficiency and reduce required postprocessing for signal alignment, the microcontroller is controlled by a data analysis station (PC) over an RS-232 serial interface. The microcontroller repeatedly performs encryptions on data received via the RS-232 serial interface. At the start of the encryption sequence, the microcontroller asserts a trigger signal on one of its general purpose input/output (GPIO) pins. The oscilloscope is configured to collect the EM signal for a fixed time interval each time the trigger is asserted. This enables precise identification and alignment of the individually collected signal traces without the need for extensive post-processing. Although a trigger signal is used for experimental efficiency, the signals observed have several obvious amplitude-response features that would allow for similar results through automated post-processing and alignment without the aid of a trigger signal.

Initial experiments showed that the unintentional EM emissions exhibit some temperature-dependency as the microcontroller warms up to its normal operating temperature. To compensate for this effect, the device is operated for 10 minutes to allow temperature stabilization before collecting data. After the initial warm-up period, training and target signal traces are collected. No attempt was made to isolate the data collection system from background environmental noise – all collections are performed in an office building environment with numerous co-located PCs and wireless devices.

3.9.3 Feature Extraction and Classification.

Once training and target signal traces are collected, identification of important amplitude-response features is accomplished with the correlation technique described in Section 2.3.1. This is followed by template construction and classification described in Sections 2.4.3.1 and 2.4.3.2. MATLAB's [TM10] "corr" and "classify" functions are used to implement the correlation and classification techniques.

3.10 Experimental Design

For two encryption algorithms and two template attack techniques, four experimental configurations are evaluated. With only four experiments, experimental reduction techniques are not necessary. Also, based on low variability in previous experiments, no more than five replications are expected to make conclusions with 90% confidence.

3.11 Methodology Summary

This chapter describes the methodology to determine the effectiveness of the Single Keybit Template Attack. The system under test and component under test were defined as well as the system parameters, factors, levels and workloads that affect performance. Measures of performance were explained and justified while system services were described. The experimental technique and design were also discussed. Chapter 4 contains the results of these experiments that lead to data analysis and conclusions in Chapter 5.

IV. Results

This chapter contains results and provides evaluations for the four measurements of performance described in Section 3.5.

4.1 DES

SKTA and TEDA are trained with signal traces collected while the encryption device performs DES encryptions. After the training, the number of observed target signal traces needed before the encryption key can be extracted is displayed in Figure 18. The key guessing entropy, which is the percentage of correct keybits discovered by each template attack, is displayed in Figure 19.

4.1.1 Number of Observations.

Displayed in Table 2 are the number of observations required by SKTA for five replications and TEDA for eight replications. These values are plotted in Figure 18 with 90% confidence levels.

As hypothesized, SKTA requires fewer observations of target signal traces than TEDA. SKTA requires an average of 320 target signal traces compared to 1320 for TEDA. Again, this outcome is expected because the DES algorithm operates on encryption keybits 12-15 times during each encryption cycle whereas the S-box inputs, required by TEDA, are only accessed once.

Table 2. Number of Observations for DES

Replication	1	2	3	4	5	6	7	8
SKTA	389	314	39	78	780	-	-	-
TEDA	1762	537	83	846	3103	2615	792	824

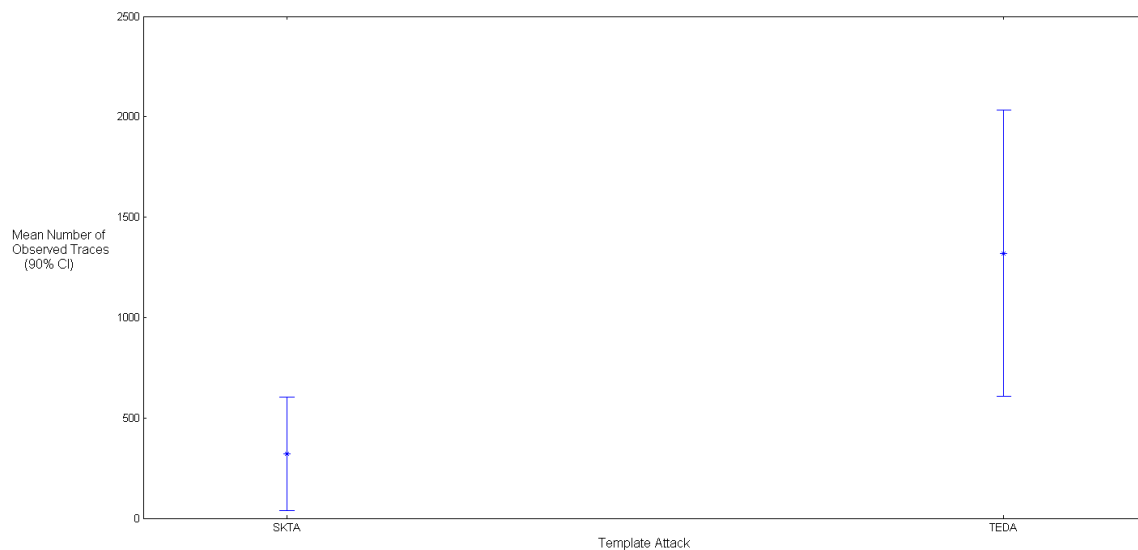

Figure 18. DES: Number of target signal trace observations for SKTA and TEDA

4.1.2 Key Guessing Entropy.

Displayed in Table 3 are the key guessing entropy percentages produced by SKTA for five replications and TEDA for eight replications. As seen in Figure 19, TEDA produced a higher key guessing entropy percentage than SKTA. TEDA discovered 100% of the keybits for each of its eight replications while SKTA averaged 89.29% for its five replications. However, only extracting 89.29% of the DES keybits leaves a remaining six unknown keybits which can be trivially iterated through.

Table 3. Key Guessing Entropy for DES

Replication	1	2	3	4	5	6	7	8
SKTA	91.07	85.71	80.36	98.21	91.07	-	-	-
TEDA	100	100	100	100	100	100	100	100

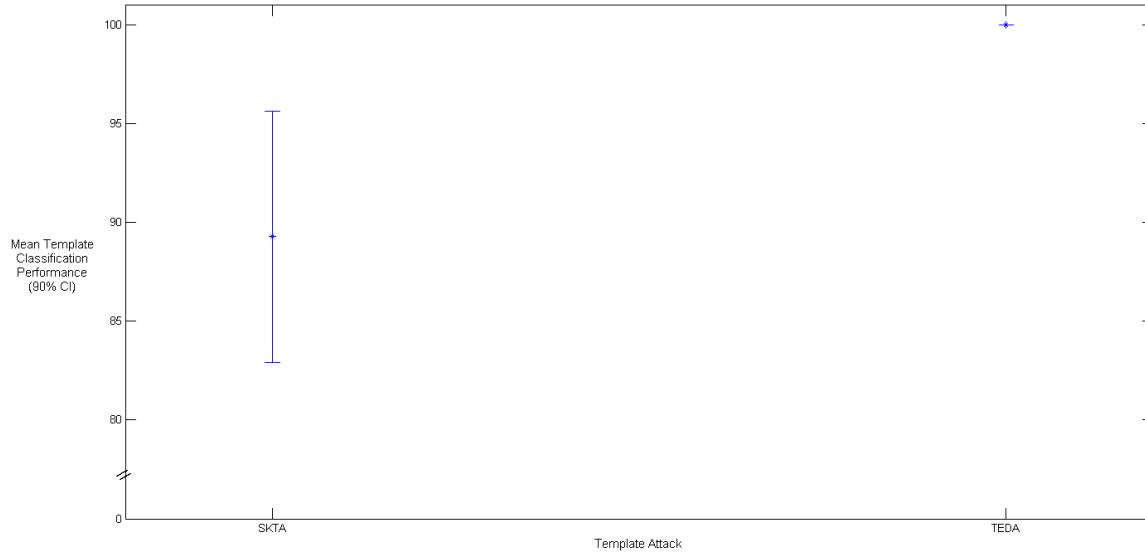

Figure 19. DES: Key guessing entropy for SKTA and TEDA

4.2 AES

For AES, SKTA and TEDA are trained with signal traces collected while the encryption device performs AES encryptions. After the training, the number of observed target signal traces needed before the encryption key can be extracted is displayed in Figure 20. The key guessing entropy, which is the percentage of correct keybits discovered by each template attack, is displayed in Figure 21.

4.2.1 Number of Observations.

Displayed in Table 4 are the number of observations required by SKTA and TEDA for five replications. These values are plotted in Figure 20 with 90% confidence levels.

As hypothesized, TEDA requires significantly fewer observations of target signal traces than SKTA on average. TEDA requires an average of 10 target signal traces compared to 919 for SKTA. Even with the large difference in their averages, the confidence intervals in Figure 20 overlap. This is because the variance for the required amount of observed traces is larger than the mean for SKTA. Again, this outcome is

expected because TEDA effectively utilizes the plaintext associated with each target signal trace when extracting a key.

Table 4. Number of Observations for AES

Replication	1	2	3	4	5
SKTA	450	2497	1249	300	100
TEDA	5	20	8	7	11

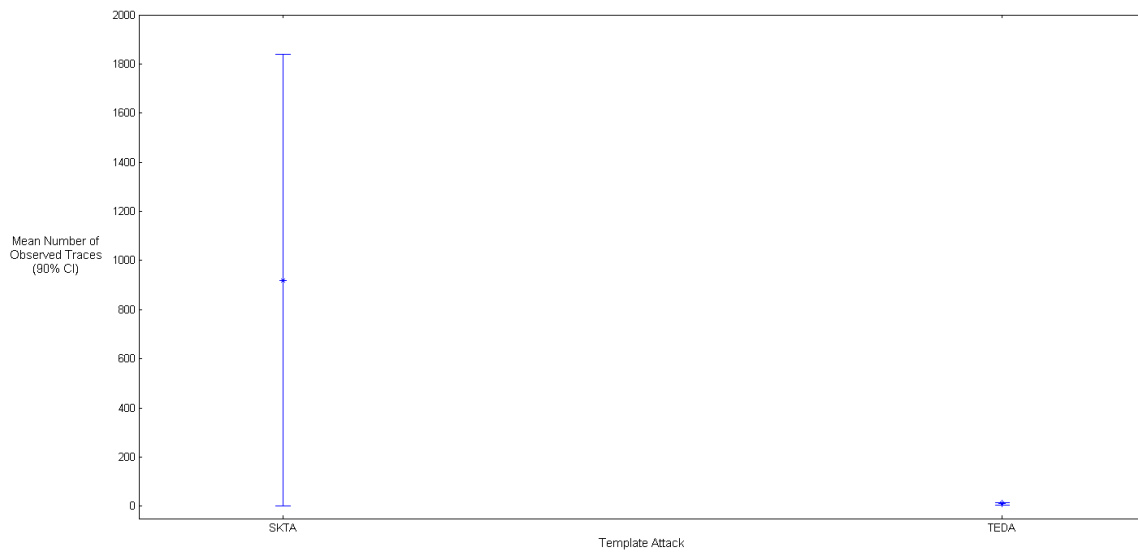

Figure 20. AES: Number of target signal trace observations for SKTA and TEDA

4.2.2 Key Guessing Entropy.

As shown in Figure 21, TEDA produced a higher key guessing entropy percentage than SKTA. TEDA discovered 100% of the keybits for each of its five replications while SKTA averaged 10.32% for its five replications. SKTA's extraction of only 10.32% of AES keybits leaves the value of 114 keybits unknown. This number of unknown keybits is impractical to iterate through.

Table 5. Key Guessing Entropy for AES

Replication	1	2	3	4	5
SKTA	9.38	11.72	13.28	5.47	15.01
TEDA	100	100	100	100	100

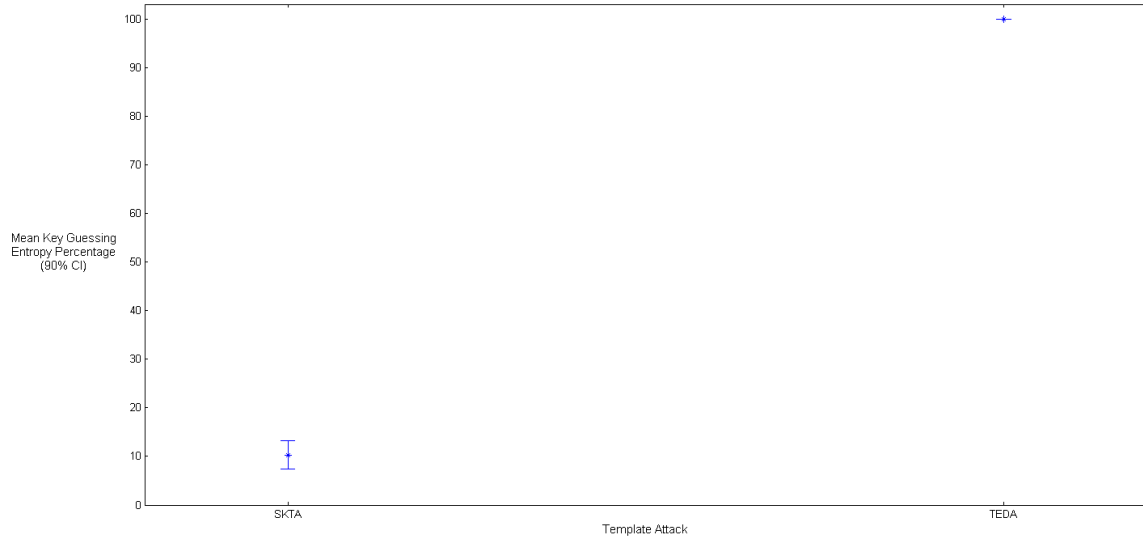

Figure 21. AES: Key guessing entropy for SKTA and TEDA

4.3 Summary

This chapter contains results for the four measures of performance collected for this research effort. Chapter 5 provides an analysis and summary of the results presented in Chapter 4. It also gives suggestions for follow-on research.

V. Conclusion

This chapter provides an analysis and summary of results presented in Chapter 4. It also discusses limitations of the findings and describes the challenges encountered in this research. Also given are suggestions for follow-on research.

5.1 Summary of Findings

Chapter 3 introduced four investigative questions which encompass the goals of this research. The investigative questions are reproduced below and a summary response for each provided based on results in Chapter 4.

1. Is the Single Keybit Template Attack (SKTA) effective?

According to the results, SKTA is only effective for DES. Further research is needed to determine why it is not effective for AES even though the keybit correlations are higher than the DES keybit correlations. One reason may be because bits being processed at the same time as the targeted keybit may exert a constant power influence during AES encryptions while their power influence is averaged out during DES encryptions.

2. Under what configuration(s) is SKTA most effective?

This research can only claim that DES is effective under the experimental configuration described in Chapter 3. This configuration included the use of a 16-bit general purpose microcontroller running a typical DES algorithm. This configuration was used to analyze signal trace data with a bandwidth of 200 MHz. Experimental performance using other bandwidths is provided in Appendix A.A.2. Signal traces were converted to the wavelet domain for training and classification. Further experimental results regarding performance with respect to the signal domain are in Appendix A.A.1.

3. For specific measures of performance, how effective is SKTA compared to TEDA?

For DES, SKTA extracted the encryption key with 312% fewer target traces than TEDA. With respect to key guessing entropy, both template attacks are essentially identical. For AES, SKTA was not effective. Using SKTA, with AES, does not increase the key guessing entropy percentage enough to make the attack practical.

4. Under what conditions and scenarios is SKTA preferred over TEDA?

SKTA is preferred over TEDA if the target signal traces are DES-based or the signal traces are acquired without the accompanying plaintext. Also, if the plaintexts for the target signal traces are not available, then SKTA is the only option. For AES, SKTA is not preferred because it can only target keybits which is apparently not enough information to extract the key.

5.2 Limitations of Findings

All experiments are performed on a general-purpose microcontroller. However, all trends in these results should concur with observable trends using other device types.

5.3 Suggested Follow-on Research

Why SKTA is not effective against AES is an open question. One possible reason for its ineffectiveness may be due to the influence of other keybits that are processed during the targeted keybit processing. Therefore, an evaluation of SKTA which removes the effects of non-targeted keybits is warranted. The analysis of other device types such as FPGAs, smartcards and cellular phones could also provide further insight into SKTA effectiveness. In addition, encryption schemes which contain SCA specific countermeasures could be evaluated. Finally, the development of an AES-

based encryption scheme which processes more than eight bits at a time might prove more challenging to many SCA techniques.

5.4 Summary

This research is the first to evaluate SKTA and has determined that SKTA is more effective than TEDA for DES-based signal traces. It also determined that for AES-based signal traces, with accompanying plaintext or ciphertext, TEDA is the preferred choice. Chapter 5 also provides the research limitations and several suggestions for follow-on research.

Appendices

Appendix A. Pilot Studies

This appendix provides experimental results and evaluations for two pilot studies regarding signal domains and data bandwidths.

A.1 Signal Domain

The first pilot study determines the SKTA's effectiveness across three signal domains: time, frequency and wavelet. This signal domain pilot study is motivated by previous experiments that indicate enhanced template classification performance in the wavelet domain. The rationale for choosing the signal domain for a pilot study, instead of as another experimental factor, is driven by the large amount of computation to move from one domain to another.

Transforming from the time domain to the wavelet or frequency domain reduces the number of dimensions in each signal trace by one-half. Needless to say, reducing the amount of data to process while maintaining similar template classification results is a great time and computational benefit.

The measure of performance for this pilot study is the template classification success rate and is measured as a percentage. This metric is a measure of how accurately the template classifier can train itself to distinguish between two templates where the targeted keybit used to build each template is either a "1" or "0". To train the classifier, it is provided training signal traces collected while an encryption device performs encryptions using random keys and random plaintexts for each encryption.

After the data is collected, it is classified using a certain percentage of the traces for training the classifier while the remaining traces are used to test the classifier. The percentage of traces used for training and testing is determined by the k-fold value. The k-fold value is used to partition the data into k equally sized subgroups; k-1 subgroups train the classifier and the remaining subgroup tests the classifier.

This process is repeated k times and ensures all traces are used to train and test the classifier. The accuracy of each of the k classifications is averaged and used to rate the overall classification accuracy and is calculated using sufficient k-fold iterations to provide a resolution of .01%.

Figures 22 and 23 display the template classification performance for the DES and AES encryption algorithms. In both cases, the wavelet domain has a slightly higher performance than the time domain while the frequency domain places a distant third. If the wavelet domain's performance was equal to that of the time domain, then the wavelet domain would still have been chosen because it has half the dimensions as the time domain. Based on the results from this pilot study, the wavelet domain is chosen as the signal domain for experiments described in Chapters 3 and 4.

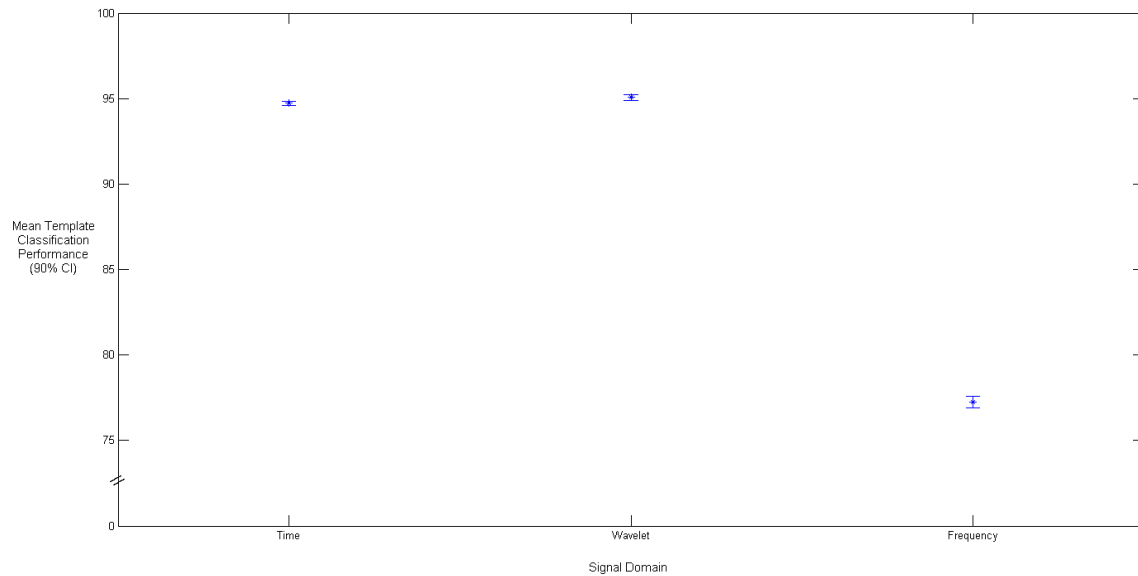

Figure 22. DES Template Classification Performance with Respect to Signal Domain

A.2 Data Bandwidth

The second pilot study is focused on the bandwidth of the data collected. In current literature, bandwidth varies between 125 MHz to 1 GHz or higher. This study

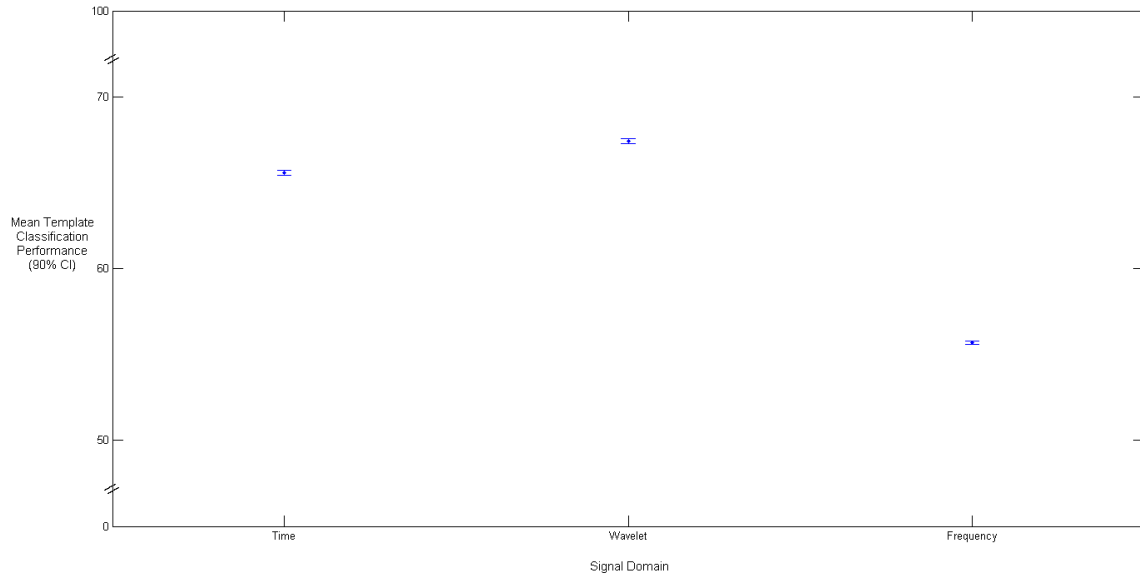

Figure 23. AES Template Classification Performance with Respect to Signal Domain

examines bandwidths of 250 MHz, 500 MHz and 1 GHz. The rationale for studying data bandwidth is based on previous experimental results that indicate a positive linear relationship between bandwidth and template attack performance. This pilot study uses SKTA on discrete bandwidths and the same measure of performance described in the first pilot study. Results for AES and DES are displayed in Figures 24 and 25. Both figures show the same trend in performance as bandwidth increases from 250 MHz to 1 GHz. Surprisingly, the performance increases as bandwidth decreases. Therefore, for DES, multiple other bandwidths are also evaluated. Figure 25, indicates a bandwidth in the range of 200 MHz to 500 MHz should provide the best performance with respect to the discrete bandwidths evaluated. Therefore, based on these results and technical conveniences of the collection equipment, a bandwidth of 200 MHz is chosen for all experiments discussed in Chapters 3 and 4.

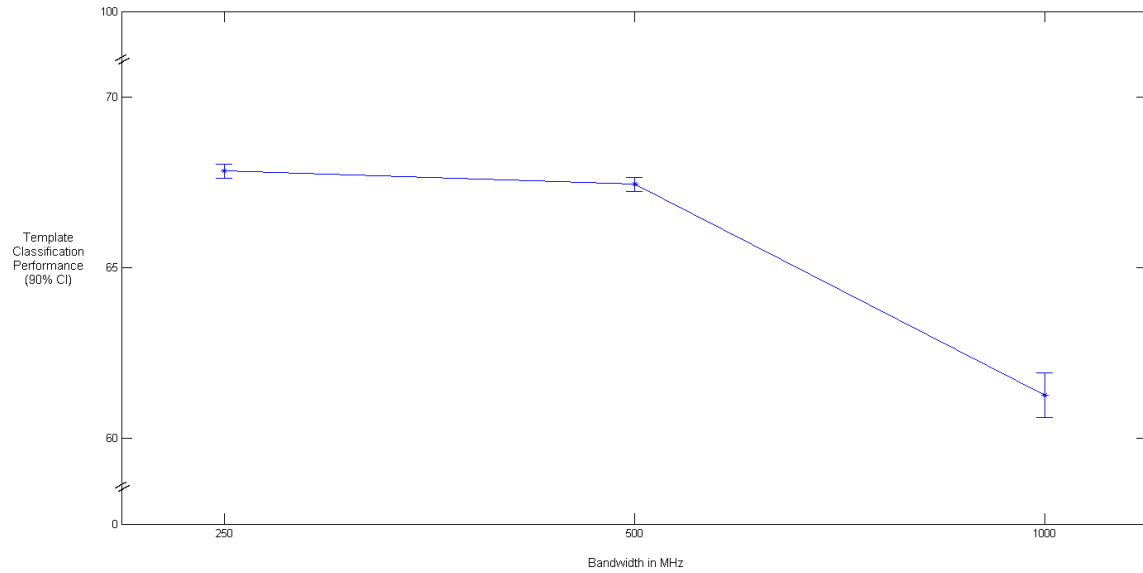

Figure 24. AES Template Classification Performance with Respect to Bandwidth

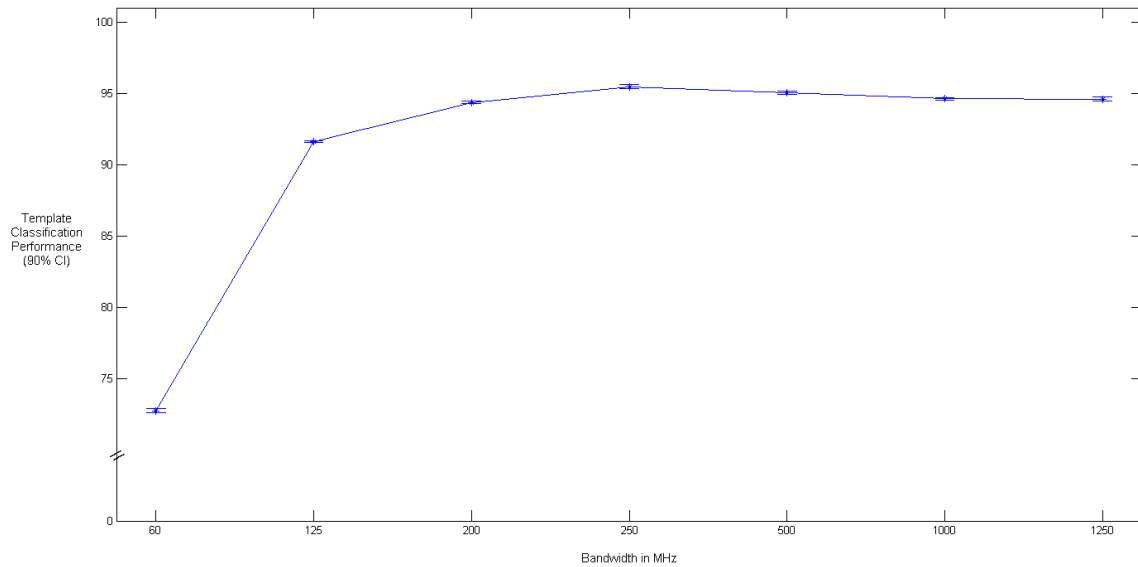

Figure 25. DES Template Classification Performance with Respect to Bandwidth

Bibliography

- [ARRS05] Daks Agrawal, Josyula R. Rao, Pankaj Rohatgi, and Kai Schramm. Templates as Master Keys. In *CHES*, volume 3659 of *Lecture Notes in Computer Science*, pages 15–29, 2005.
- [Cor06] ReliaSoft Corporation. Reference for weibull 7, 2006. http://www.weibull.com/LifeDataWeb/lifedataweb.htm#statistical_background.htm.
- [CRR02] Suresh Chari, Josyula R. Rao, and Pankaj Rohatgi. Template Attacks. In *CHES '02: Revised Papers from the 4th International Workshop on Cryptographic Hardware and Embedded Systems*, pages 13–28, 2002.
- [DR98] Joan Daemen and Vincent Rijmen. Aes Proposal: Rijndael, September 1998.
- [FXSY09] Tal Malkin Francois-Xavier Standaert and Moti Yung. A Unified Framework for the Analysis of Side-Channel Key Recovery Attacks. 2009.
- [HTM09] Neil Hanley, Michael Tunstall, and William P. Marnane. Unknown Plaintext Template Attacks. In *Workshop on Information Security Applications WISA 2009*, pages 148–162, December 2009.
- [Kay98] S. M. Kay. *Fundamentals of Statistical Signal Processing: Detection Theory*. Prentice Hall, 1998. ISBN-13: 978-0135041352.
- [KJJ99] Paul C. Kocher, Joshua Jaffe, and Benjamin Jun. Differential Power Analysis. In *CRYPTO '99: Proceedings of the 19th Annual International Cryptology Conference on Advances in Cryptology*, pages 388–397, 1999.
- [MOP07] Stefan Mangard, Elisabeth Oswald, and Thomas Popp. *Power Analysis Attacks: Revealing the Secrets of Smart Cards*. Springer-Verlag New York, Inc., 2007.
- [MTI08] Microchip Technology Inc. 16-bit 28-pin Starter Development Board Users Guide, 2008. <http://ww1.microchip.com/downloads/en/DeviceDoc/51656B.pdf>.
- [MTI10] Microchip Technology Inc. Pic24f Family Reference Manual, 2010. <http://www.microchip.com/wwwproducts/Devices.aspx?dDocName=en520626>.
- [NIS] National Institute for Standards and Technology. <http://www.nist.gov>.
- [NIS77] *Data Encryption Standard (FIPS PUB 46-1)*. National Institute for Standards and Technology, January 1977. <http://www.itl.nist.gov/fipspubs/fip46-2.htm>.

- [NIS99] *Triple DES (FIPS PUB 46-3)*. National Institute for Standards and Technology, October 1999. <http://csrc.nist.gov/publications/fips/fips46-3/fips46-3.pdf>.
- [NIS01] *Advanced Encryption Standard (FIPS PUB-197)*. National Institute for Standards and Technology, November 2001. <http://csrc.nist.gov/publications/fips/fips197/fips-197.pdf>.
- [OM07] Elisabeth Oswald and S. Mangard. Template Attacks on Masking - Resistance is futile. In *CT-RSA*, pages 243–256, August 2007.
- [PEK⁺09] Christof Paar, Thomas Eisenbarth, Markus Kasper, Timo Kasper, and Amir Moradi. Keeloq and Side-Channel Analysis-Evolution of an Attack. In *Proceedings of the 2009 Workshop on Fault Diagnosis and Tolerance in Cryptography*, FDTC '09, pages 65–69. IEEE Computer Society, 2009.
- [QS01] Jean-Jacques Quisquater and David Samyde. Electromagnetic Analysis (ema): Measures and Counter-Measures for Smart Cards. In *E-SMART '01: Proceedings of the International Conference on Research in Smart Cards*, pages 200–210, 2001.
- [RO04] Christian Rechberger and Elisabeth Oswald. Practical Template Attacks. In *WISA*, volume 3325 of *Lecture Notes in Computer Science*, pages 440–456, 2004.
- [TK09] Sergios Theodoridis and Konstantinos Koutroumbas. *Pattern Recognition*. Academic Press, 2009. fourth edition.
- [TM10] The MathWorks. <http://www.mathworks.com/products/matlab/>, 2010. Ver. R2010b.

Vita

Capt Eric Garcia was born in Houston, Texas. After graduating from North Shore High School, he studied Electrical Engineering at the University of Texas at San Antonio. He graduated with his Bachelor's Degree in Electrical Engineering in May of 2003. Capt Garcia commissioned into the United States Air Force in September of 2005 through Officer Training School (OTS) at Maxwell AFB, Montgomery, Alabama. Following OTS, he was assigned to the Air Force Flight Test Center (AFFTC) where he worked for the Airborne Laser and Global Hawk flight test programs. Following his assignment to AFFTC, he entered graduate school at the Air Force Institute of Technology (AFIT) in June of 2009 and he is currently completing his Master's Degree. His follow-on assignment is to the Sensors Directorate of the Air Force Research Laboratory (AFRL/RV) at Wright-Patterson AFB, Ohio.

REPORT DOCUMENTATION PAGE

Form Approved
OMB No. 0704-0188

The public reporting burden for this collection of information is estimated to average 1 hour per response, including the time for reviewing instructions, searching existing data sources, gathering and maintaining the data needed, and completing and reviewing the collection of information. Send comments regarding this burden estimate or any other aspect of this collection of information, including suggestions for reducing this burden to Department of Defense, Washington Headquarters Services, Directorate for Information Operations and Reports (0704-0188), 1215 Jefferson Davis Highway, Suite 1204, Arlington, VA 22202-4302. Respondents should be aware that notwithstanding any other provision of law, no person shall be subject to any penalty for failing to comply with a collection of information if it does not display a currently valid OMB control number. **PLEASE DO NOT RETURN YOUR FORM TO THE ABOVE ADDRESS.**

1. REPORT DATE (DD-MM-YYYY) 24-03-2011		2. REPORT TYPE Master's Thesis		3. DATES COVERED (From — To) Jun 2009 — Mar 2011	
4. TITLE AND SUBTITLE Evaluation Of The Single Keybit Template Attack				5a. CONTRACT NUMBER	
				5b. GRANT NUMBER	
				5c. PROGRAM ELEMENT NUMBER	
6. AUTHOR(S) Eric W. Garcia, Capt, USAF				5d. PROJECT NUMBER	
				5e. TASK NUMBER	
				5f. WORK UNIT NUMBER	
7. PERFORMING ORGANIZATION NAME(S) AND ADDRESS(ES) Air Force Institute of Technology Graduate School of Engineering and Management (AFIT/EN) 2950 Hobson Way WPAFB OH 45433-7765				8. PERFORMING ORGANIZATION REPORT NUMBER AFIT/GE/ENG/11-11	
9. SPONSORING / MONITORING AGENCY NAME(S) AND ADDRESS(ES) Mr. Dave Lehr, Military Intelligence Program (MIP) Investment Manager D/Chief - Technical Integration Division (S33P2) Rm: 2B5060 ISR Portfolio Management Office (S33P), Data Acquisitions (S3) National Security Agency / Central Security Service (NSA/CSS) 9800 Savage Rd., Fort Meade, MD 20755 E-mail: cdlehr1@nsa.gov, Comm: 240-373-2548				10. SPONSOR/MONITOR'S ACRONYM(S)	
				11. SPONSOR/MONITOR'S REPORT NUMBER(S)	
12. DISTRIBUTION / AVAILABILITY STATEMENT APPROVED FOR PUBLIC RELEASE; DISTRIBUTION UNLIMITED. This material is declared a work of the U.S. Government and is not subject to copyright protection in the United States.					
13. SUPPLEMENTARY NOTES					
14. ABSTRACT Side Channel leakage is a serious threat to secure devices. Cryptographic information extraction is possible after examining any one of the various side channels, including electromagnetic. This work contributes a new method to achieve such a purpose. The Single Keybit Template Attack (SKTA) is introduced as a means to extract encryption keys from embedded processors and other integrated circuit devices performing DES encryptions by passively monitoring and exploiting unintentional RF emissions. Key extraction is accomplished by creating two templates for each bit value of the key based on instantaneous amplitude responses as a device executes DES operations. The resultant templates are input to a Maximum Likelihood processor for subsequent template discrimination with RF emissions captured from a target device. Plaintext and ciphertext are not necessary for SKTA to function. Using 8-bit microcontroller devices and experimentally collected side channel signals, key extraction is possible after examination of approximately 300 RF emission traces. After consideration of SKTA's capabilities, embedded processors using DES to process sensitive data warrants reconsideration.					
15. SUBJECT TERMS Template Analysis, Template Attack, Side-Channel Analysis, Side-Channel Attack, Keybit					
16. SECURITY CLASSIFICATION OF:			17. LIMITATION OF ABSTRACT	18. NUMBER OF PAGES	19a. NAME OF RESPONSIBLE PERSON
a. REPORT	b. ABSTRACT	c. THIS PAGE			Dr. Rusty O. Baldwin, ENG
U	U	U	U U	63	19b. TELEPHONE NUMBER (include area code) (937) 785-3636 x4445; Rusty.Baldwin@afit.edu